

## Silicon Power Transistors

The MJ15022 and MJ15024 are PowerBase power transistors designed for high power audio, disk head positioners and other linear applications.

- High Safe Operating Area (100% Tested) —  
2 A @ 80 V
- High DC Current Gain —  
 $h_{FE} = 15$  (Min) @  $I_C = 8$  Adc

**NPN**  
**MJ15022**  
**MJ15024\***

\*Motorola Preferred Device

**16 AMPERE**  
**SILICON**  
**POWER TRANSISTORS**  
**200 AND 250 VOLTS**  
**250 WATTS**

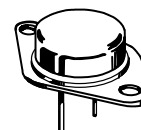

**CASE 1-07**  
**TO-204AA**  
**(TO-3)**

### MAXIMUM RATINGS

Rating	Symbol	MJ15022	MJ15024	Unit
Collector-Emitter Voltage	$V_{CEO}$	200	250	Vdc
Collector-Base Voltage	$V_{CB0}$	350	400	Vdc
Emitter-Base Voltage	$V_{EBO}$	5		Vdc
Collector-Emitter Voltage	$V_{CEX}$	400		Vdc
Collector Current — Continuous Peak (1)	$I_C$	16 30		Adc
Base Current — Continuous	$I_B$	5		Adc
Total Power Dissipation @ $T_C = 25^\circ\text{C}$ Derate above $25^\circ\text{C}$	$P_D$	250 1.43		Watts W/ $^\circ\text{C}$
Operating and Storage Junction Temperature Range	$T_J, T_{stg}$	-65 to +200		$^\circ\text{C}$

### THERMAL CHARACTERISTICS

Characteristic	Symbol	Max	Unit
Thermal Resistance, Junction to Case	$R_{\theta JC}$	0.70	$^\circ\text{C/W}$

(1) Pulse Test: Pulse Width = 5 ms, Duty Cycle  $\leq$  10%.

**Preferred** devices are Motorola recommended choices for future use and best overall value.

REV 7

# MJ15022 MJ15024

## ELECTRICAL CHARACTERISTICS (T<sub>C</sub> = 25°C unless otherwise noted)

Characteristic	Symbol	Min	Max	Unit
<b>OFF CHARACTERISTICS</b>				
Collector–Emitter Sustaining Voltage (1) (I <sub>C</sub> = 100 mAdc, I <sub>B</sub> = 0)	MJ15022 MJ15024	V <sub>CEO(sus)</sub>	200 250	—
Collector Cutoff Current (V <sub>CE</sub> = 200 Vdc, V <sub>BE(off)</sub> = 1.5 Vdc) (V <sub>CE</sub> = 250 Vdc, V <sub>BE(off)</sub> = 1.5 Vdc)	MJ15022 MJ15024	I <sub>CEX</sub>	— —	250 250
Collector Cutoff Current (V <sub>CE</sub> = 150 Vdc, I <sub>B</sub> = 0) (V <sub>CE</sub> = 200 vdc, I <sub>B</sub> = 0)	MJ15022 MJ15024	I <sub>CEO</sub>	— —	500 500
Emitter Cutoff Current (V <sub>CE</sub> = 5 Vdc, I <sub>B</sub> = 0)		I <sub>EBO</sub>	—	500

## SECOND BREAKDOWN

Second Breakdown Collector Current with Base Forward Biased (V <sub>CE</sub> = 50 Vdc, t = 0.5 s (non-repetitive)) (V <sub>CE</sub> = 80 Vdc, t = 0.5 s (non-repetitive))	I <sub>S/b</sub>	5 2	— —	Adc
---	------------------	--------	--------	-----

## ON CHARACTERISTICS

DC Current Gain (I <sub>C</sub> = 8 Adc, V <sub>CE</sub> = 4 Vdc) (I <sub>C</sub> = 16 Adc, V <sub>CE</sub> = 4 Vdc)	h <sub>FE</sub>	15 5	60 —	—
Collector–Emitter Saturation Voltage (I <sub>C</sub> = 8 Adc, I <sub>B</sub> = 0.8 Adc) (I <sub>C</sub> = 16 Adc, I <sub>B</sub> = 3.2 Adc)	V <sub>CE(sat)</sub>	— —	1.4 4.0	Vdc
Base–Emitter On Voltage (I <sub>C</sub> = 8 Adc, V <sub>CE</sub> = 4 Vdc)	V <sub>BE(on)</sub>	—	2.2	Vdc

## DYNAMIC CHARACTERISTICS

Current–Gain — Bandwidth Product (I <sub>C</sub> = 1 Adc, V <sub>CE</sub> = 10 Vdc, f <sub>test</sub> = 1 MHz)	f <sub>T</sub>	4	—	MHz
Output Capacitance (V <sub>CB</sub> = 10 Vdc, I <sub>E</sub> = 0, f <sub>test</sub> = 1 MHz)	C <sub>ob</sub>	—	500	pF

(1) Pulse Test: Pulse Width = 300 μs, Duty Cycle ≤ 2%.

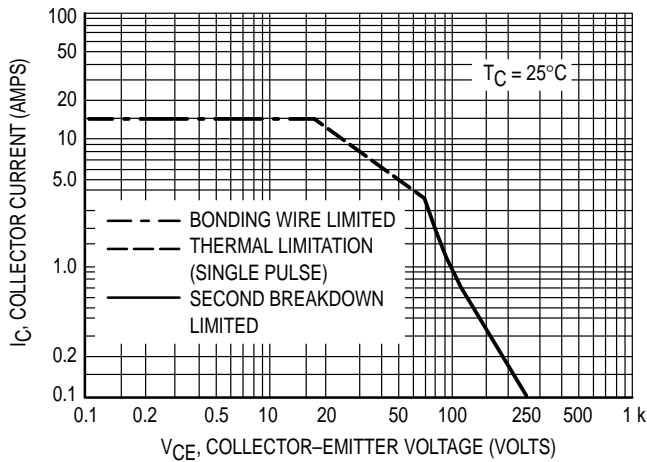

**Figure 1. Active–Region Safe Operating Area**

There are two limitations on the powerhandling ability of a transistor: average junction temperature and second breakdown. Safe operating area curves indicate I<sub>C</sub> – V<sub>CE</sub> limits of the transistor that must be observed for reliable operation; i.e., the transistor must not be subjected to greater dissipation than the curves indicate.

The data of Figure 1 is based on T<sub>J(pk)</sub> = 200°C; T<sub>C</sub> is variable depending on conditions. At high case temperatures, thermal limitations will reduce the power that can be handled to values less than the limitations imposed by second breakdown.

TYPICAL CHARACTERISTICS

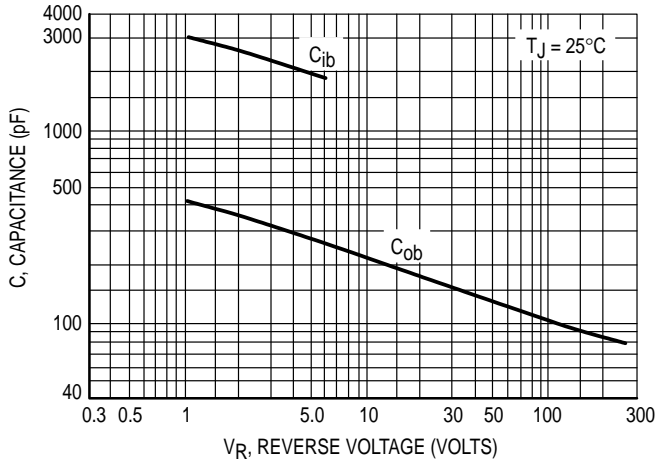

Figure 2. Capacitances

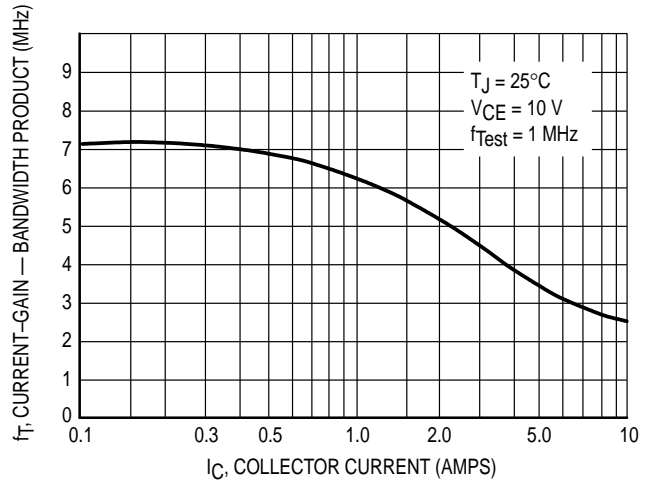

Figure 3. Current-Gain — Bandwidth Product

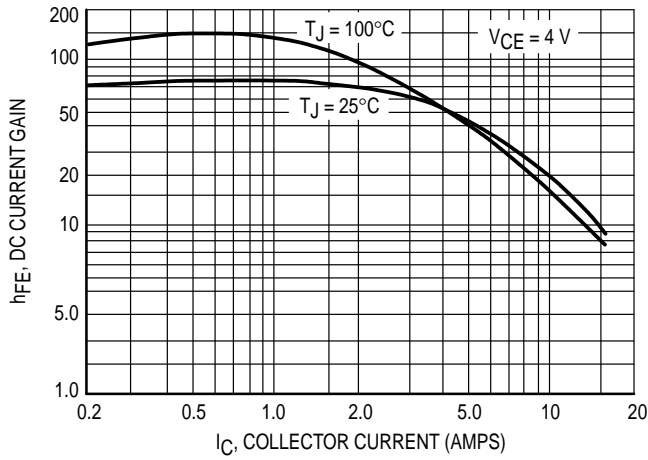

Figure 4. DC Current Gain

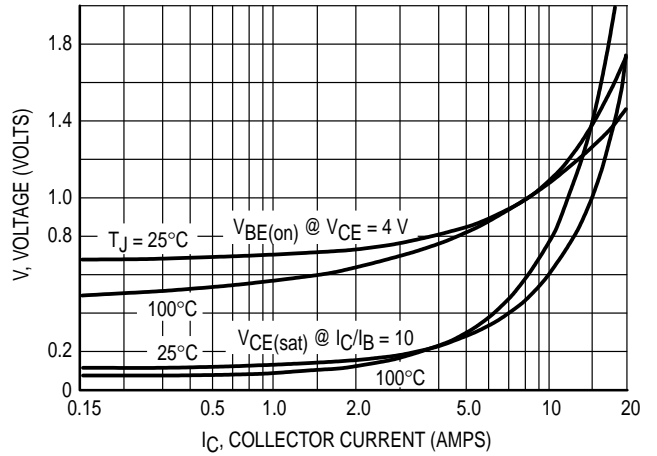

Figure 5. "On" Voltage

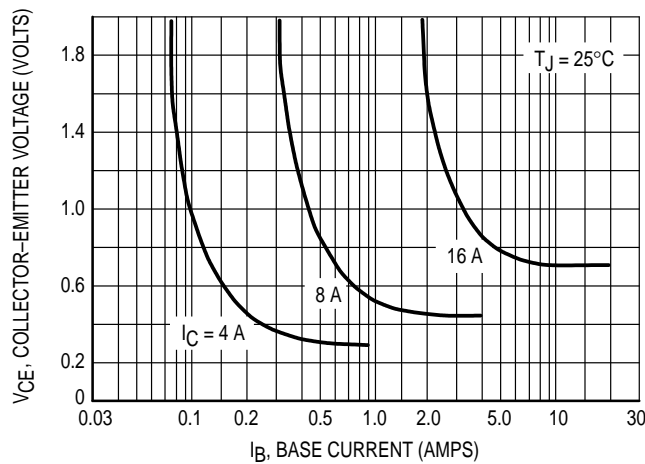
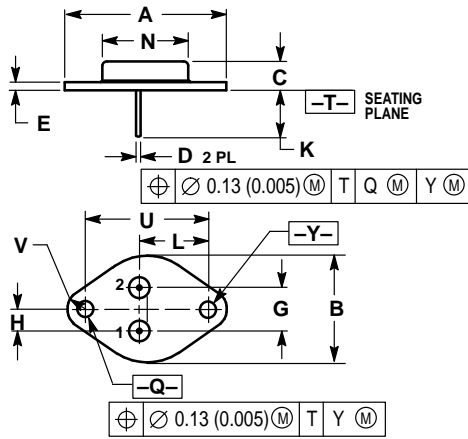

Figure 6. Collector Saturation Region

PACKAGE DIMENSIONS



- NOTES:
1. DIMENSIONING AND TOLERANCING PER ANSI Y14.5M, 1982.
  2. CONTROLLING DIMENSION: INCH.
  3. ALL RULES AND NOTES ASSOCIATED WITH REFERENCED TO-204AA OUTLINE SHALL APPLY.

DIM	INCHES		MILLIMETERS	
	MIN	MAX	MIN	MAX
A	1.550 REF		39.37 REF	
B	—	1.050	—	26.67
C	0.250	0.335	6.35	8.51
D	0.038	0.043	0.97	1.09
E	0.055	0.070	1.40	1.77
G	0.430 BSC		10.92 BSC	
H	0.215 BSC		5.46 BSC	
K	0.440	0.480	11.18	12.19
L	0.665 BSC		16.89 BSC	
N	—	0.830	—	21.08
Q	0.151	0.165	3.84	4.19
U	1.187 BSC		30.15 BSC	
V	0.131	0.188	3.33	4.77

- STYLE 1:  
 PIN 1: BASE  
 2: EMITTER  
 CASE: COLLECTOR

CASE 1-07  
 TO-204AA (TO-3)  
 ISSUE Z

Motorola reserves the right to make changes without further notice to any products herein. Motorola makes no warranty, representation or guarantee regarding the suitability of its products for any particular purpose, nor does Motorola assume any liability arising out of the application or use of any product or circuit, and specifically disclaims any and all liability, including without limitation consequential or incidental damages. "Typical" parameters can and do vary in different applications. All operating parameters, including "Typicals" must be validated for each customer application by customer's technical experts. Motorola does not convey any license under its patent rights nor the rights of others. Motorola products are not designed, intended, or authorized for use as components in systems intended for surgical implant into the body, or other applications intended to support or sustain life, or for any other application in which the failure of the Motorola product could create a situation where personal injury or death may occur. Should Buyer purchase or use Motorola products for any such unintended or unauthorized application, Buyer shall indemnify and hold Motorola and its officers, employees, subsidiaries, affiliates, and distributors harmless against all claims, costs, damages, and expenses, and reasonable attorney fees arising out of, directly or indirectly, any claim of personal injury or death associated with such unintended or unauthorized use, even if such claim alleges that Motorola was negligent regarding the design or manufacture of the part. Motorola and are registered trademarks of Motorola, Inc. Motorola, Inc. is an Equal Opportunity/Affirmative Action Employer.

How to reach us:  
**USA / EUROPE:** Motorola Literature Distribution;  
 P.O. Box 20912; Phoenix, Arizona 85036. 1-800-441-2447

**JAPAN:** Nippon Motorola Ltd.; Tatsumi-SPD-JLDC, Toshikatsu Otsuki,  
 6F Seibu-Butsuryu-Center, 3-14-2 Tatsumi Koto-Ku, Tokyo 135, Japan. 03-3521-8315

**MFAX:** RMFAX0@email.sps.mot.com - TOUCHTONE (602) 244-6609  
**INTERNET:** http://Design-NET.com

**HONG KONG:** Motorola Semiconductors H.K. Ltd.; 8B Tai Ping Industrial Park,  
 51 Ting Kok Road, Tai Po, N.T., Hong Kong. 852-26629298



This datasheet has been download from:

[www.datasheetcatalog.com](http://www.datasheetcatalog.com)

Datasheets for electronics components.