

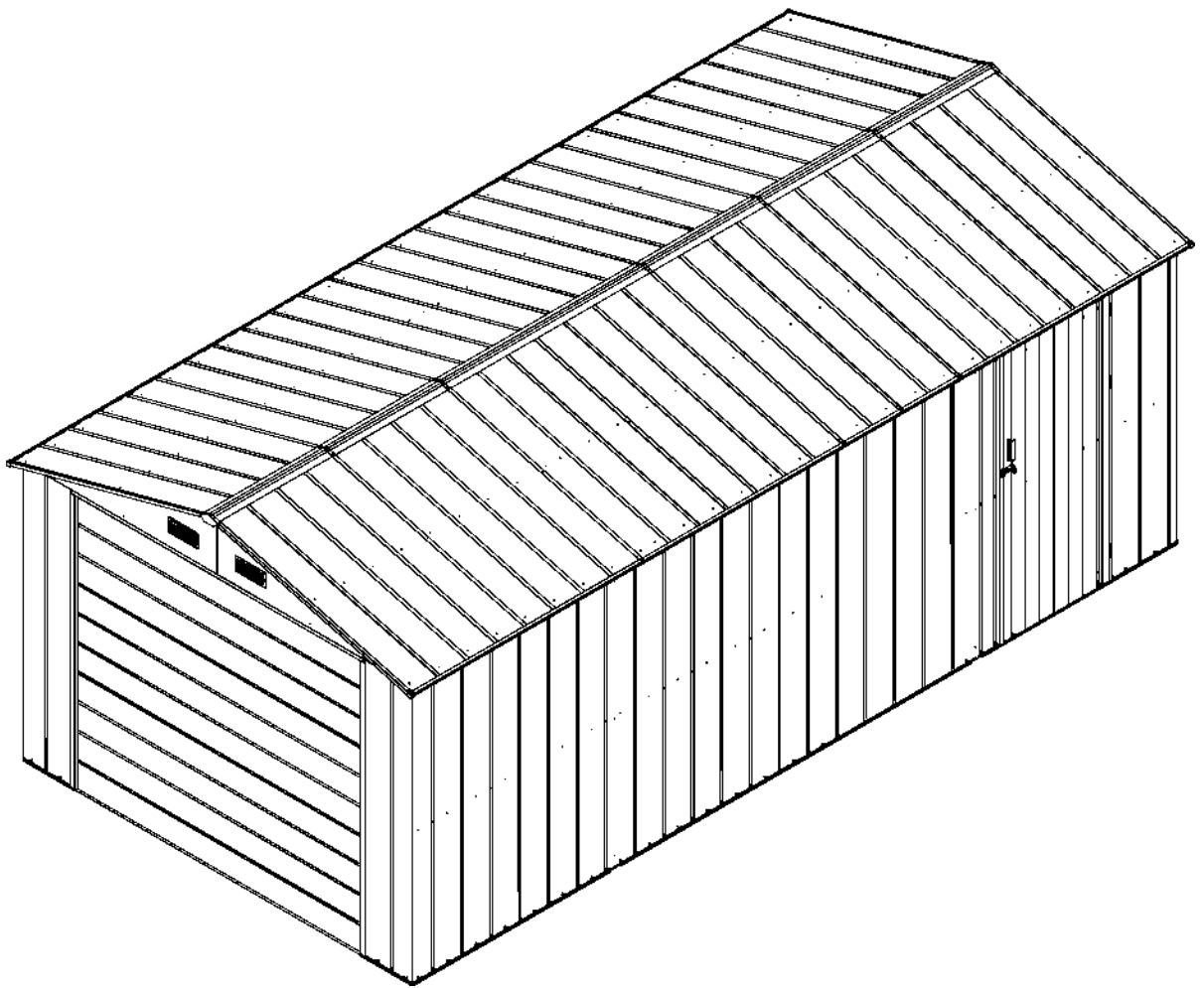























































































VILLAHOUSE A1
DELUX HARMMAA
AUTOTALLI
ASENNUSOPAS



OSALUETTELO

OSA	NRO	Määrä
	1	2
	2	2
	3	2
	3L	1
	3R	1
	4L	1
	4R	1
	5L	1
	5R	1
	6L	1
	6R	1
	7	1
	8	2
	9	2
	10L	1
	10R	1
	11	2
	12L	1
	12R	2
	12	4
	13	4
	14	4
	15	6
	16	2
	17	2
	7L	1
	7R	1
	18	2
	19	7

OSA	NRO	Määrä
	21L	2
	21R	2
	22	2
	23	1
	24	2
	25L	1
	25R	1
	35	1
	31	4
	32	4
	33	4
	34	2
	B1	2
	B2	2
	B3	4
	J4	2
	L1	16
	P1	9
	P2	2
	P3	2
	P4	1
	P5	1
	P6	1
	P7	1
	P6L	1
	P6R	1
	P4L	8
	P4R	6

OSA	NRO	Määrä
	D2	1
	30	4
	37	1
	38	1
	39	1
	40	1
	41	1
	42	2
	Nosto-oven moottori	1
	Oven kisko V	1
	Oven kisko O	1
	Peite	8
	Oven veivi	1
	F6	
	F5	100
	GC	4
	GE	2
	GF	4
	J1	4
	J2	4
	J3	2
	B5	3
	B6	9
	H1	2
	H2	2
	J5	1
	J6	1
	F1	780
	F2	130
	F3	15
	F4	17

MITAT

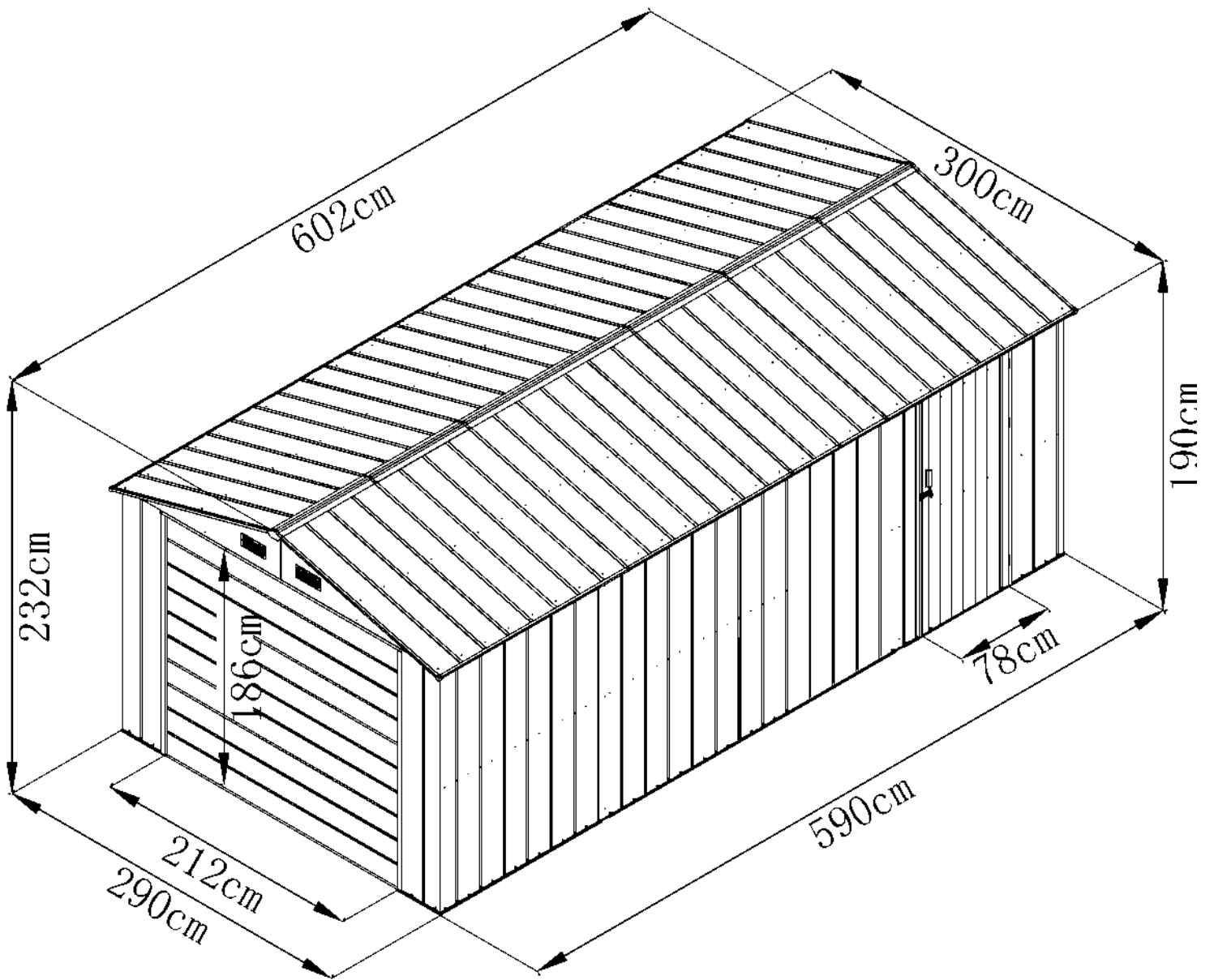

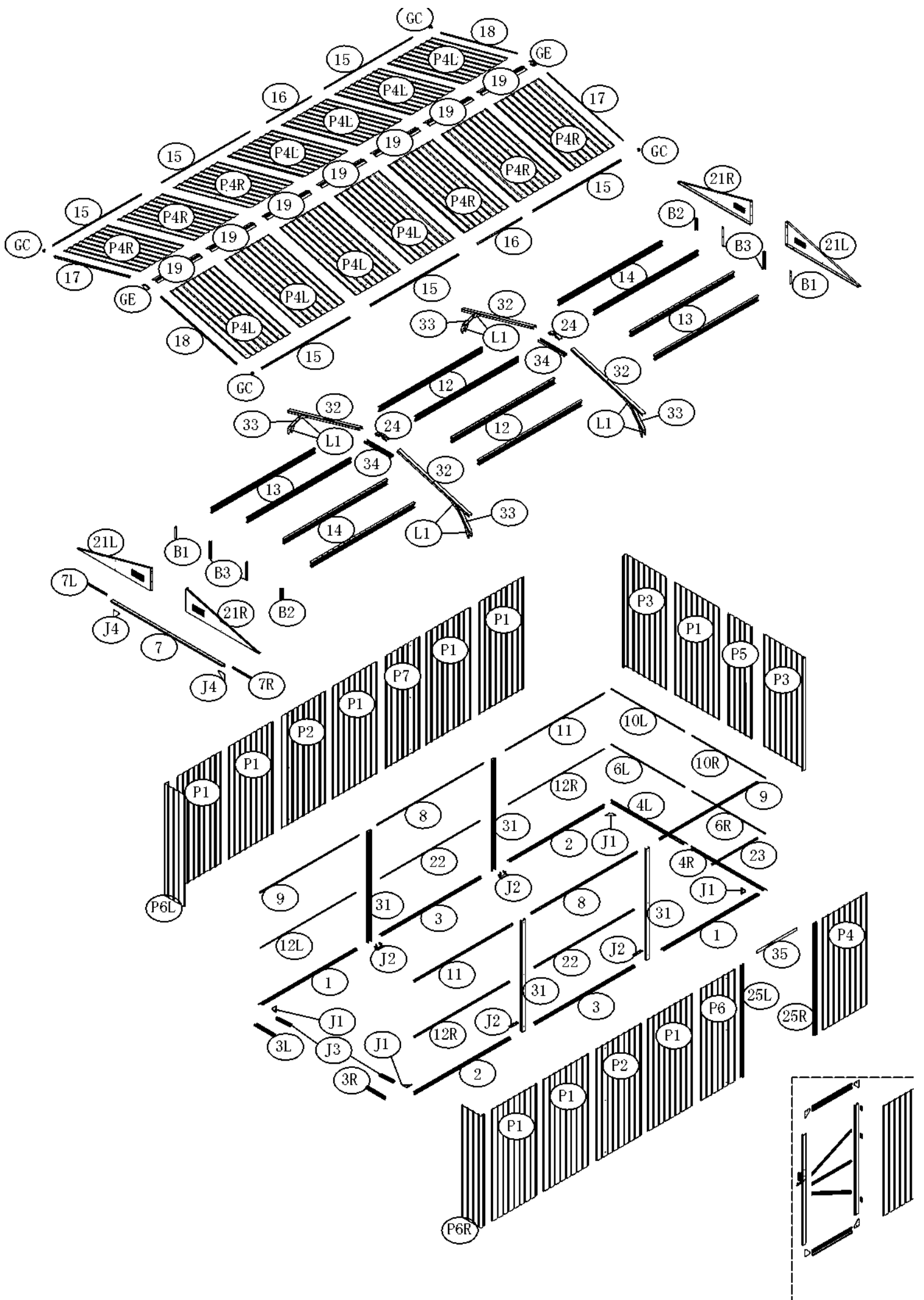

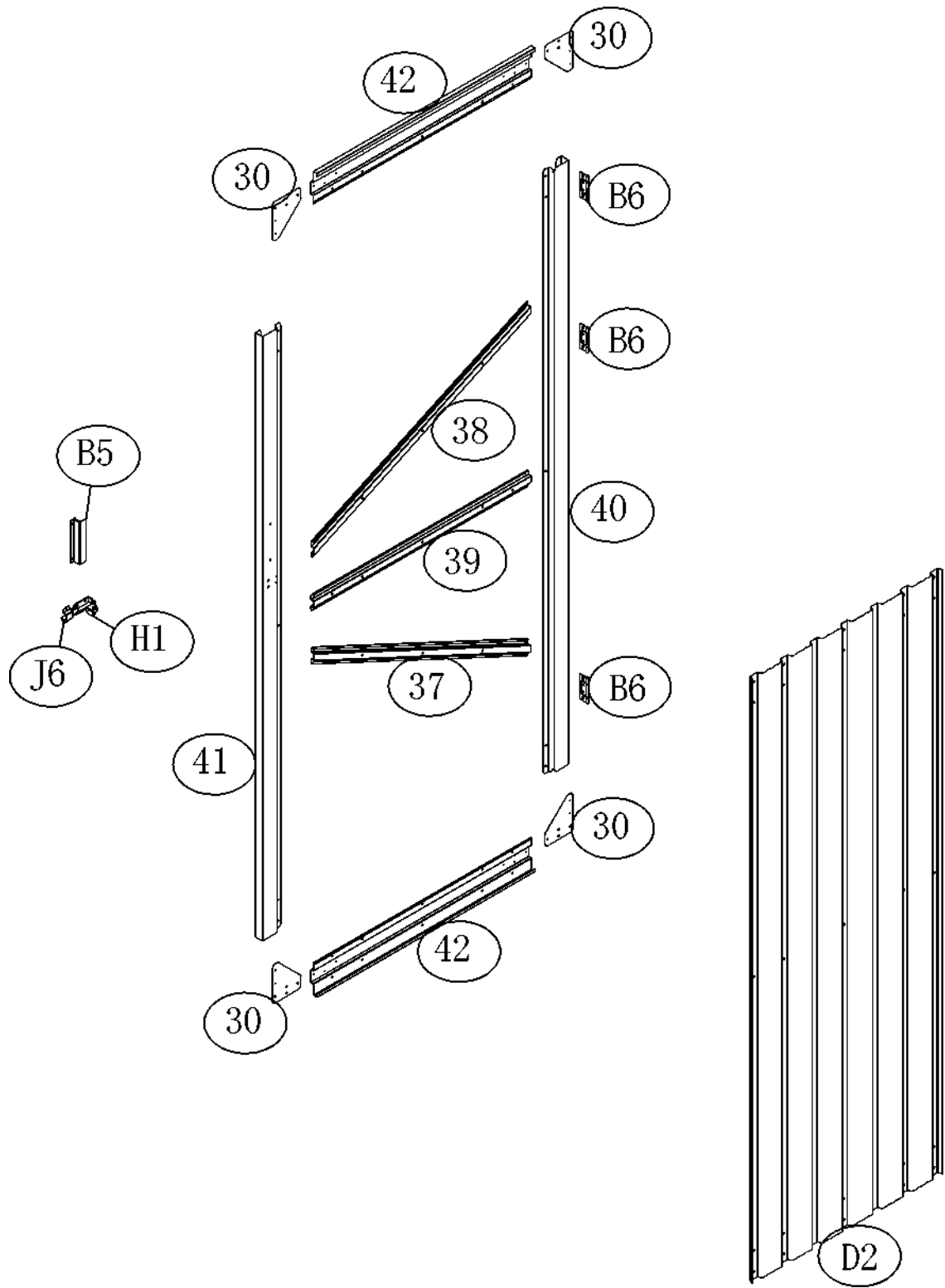

RUNGON KOKOAMINEN

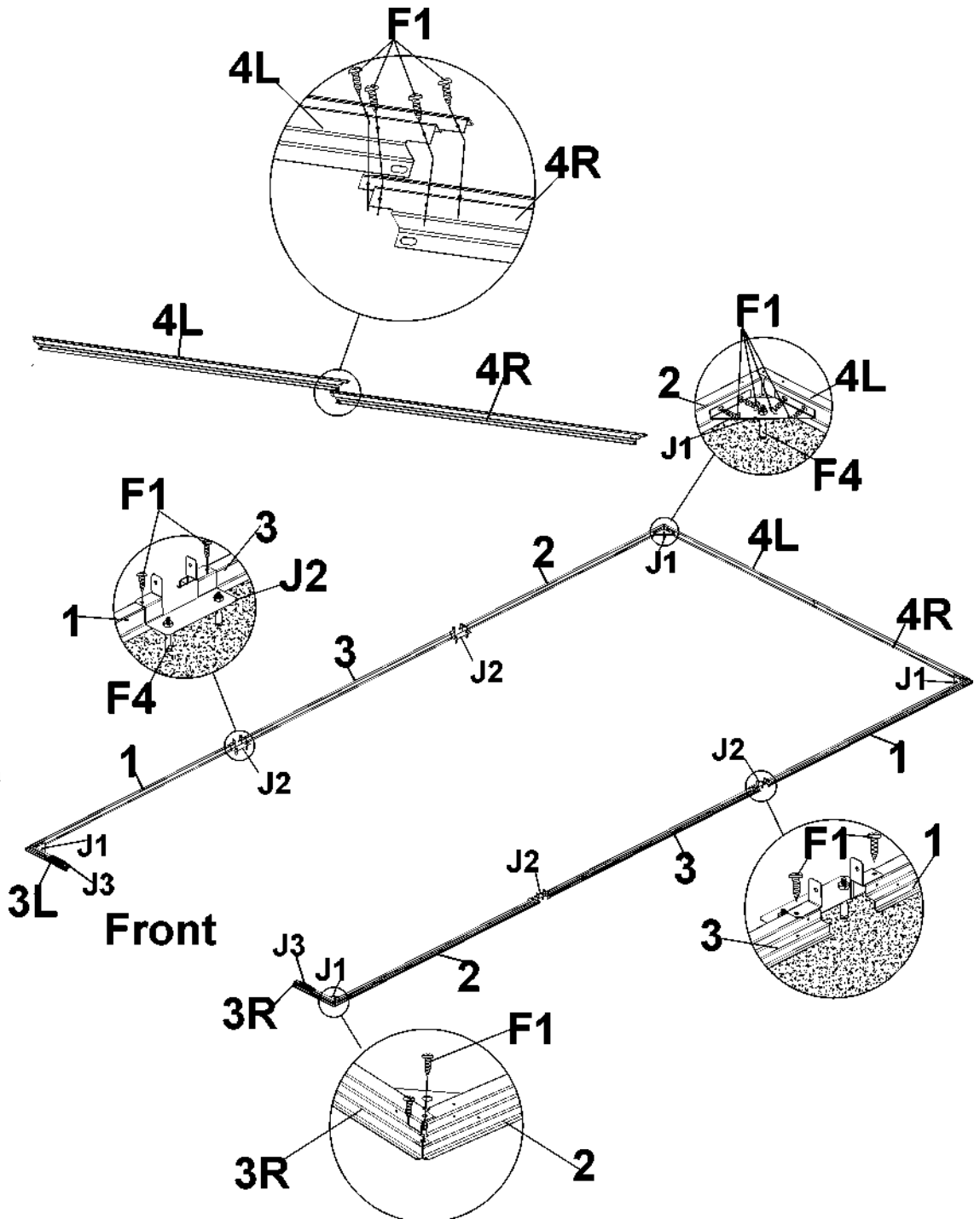

OSA NRO Määrä

	1	2
	2	2
	3L	1
	3R	1
	4L	1
	4R	1
	3	2
	J1	4
	J2	4
	J3	2
	F1	
	F4	

Varo teräviä reunoja. Käytä suojäkäsineitä.

Ota esille kuvassa näkyvät osat ja kiinnitä ne ruuveilla (F1).

Varmista, että runko kootaan täydelliseen neliöön.

* Varmista, että tukipalkit kootaan täydelliseen neliöön.

* Rungossa on ylimääräisiä reikiä. Niiden avulla talli voidaan kiinnittää puu- tai betoniperustaan.

Vielä paremman kiinnityksen saat käyttämällä ankkurointisarjojamme.

SIVUSEINÄN KOKOAMINEN

Huomaa: Jätä palkkien vasemmalle ja oikealle puolelle 7–8 cm tilaa, ks. kuva.

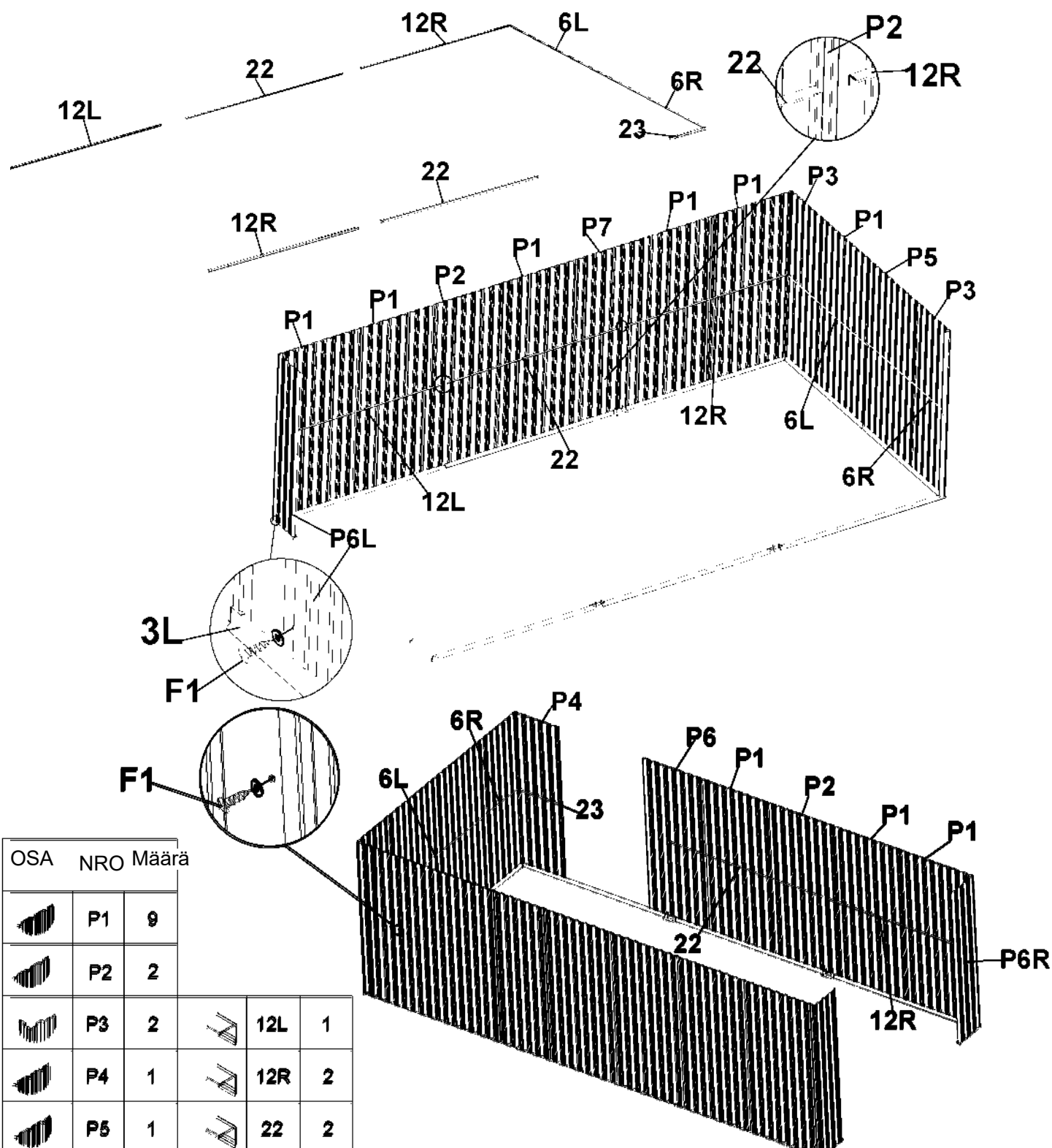





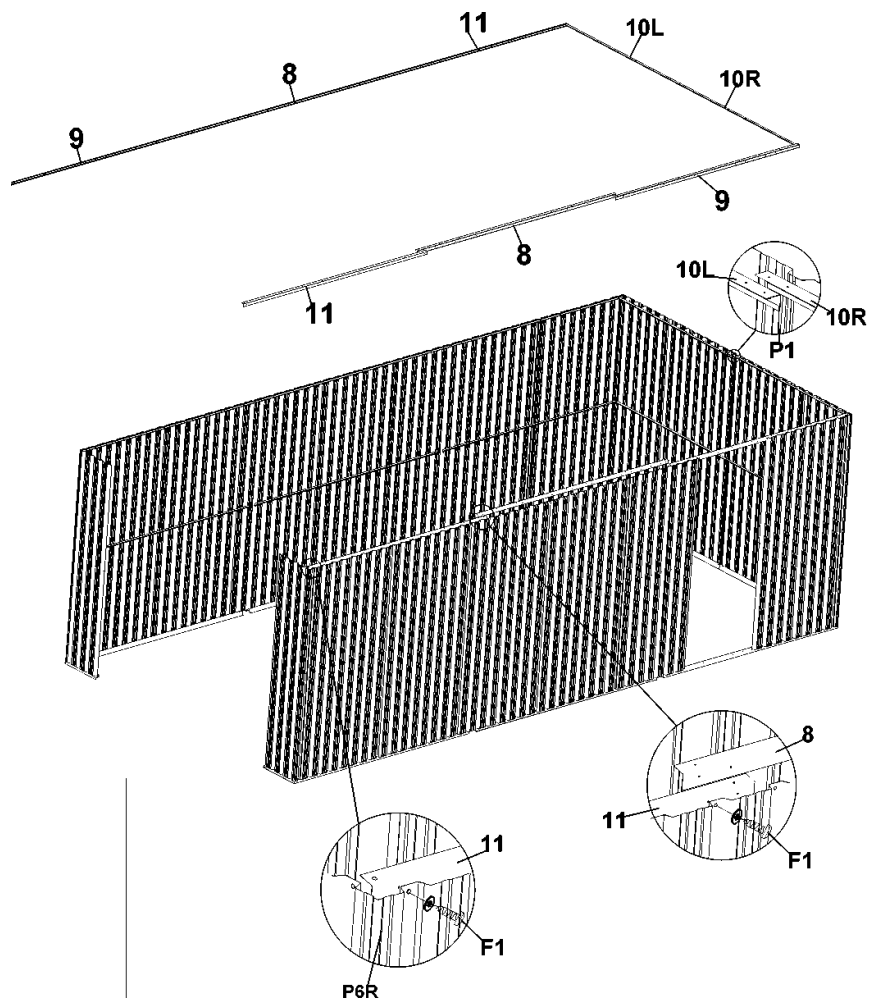

OSA	NRO	Määrä		
	P1	9		
	P2	2		
	P3	2		12L 1
	P4	1		12R 2
	P5	1		22 2
	P6	1		23 1
	P7	1		6L 1
	P6L	1		6R 1
	P6R	1		F1

Varoitus: ÄLÄ SUORITA TÄTÄ VAIHETTA TUULISENA PÄIVÄNÄ.

Ota esille kuvassa näkyvät osat. Asenna paneelit yksitellen. Kiinnitä seinän keskikohdan palkit, jotta se pysyy pystyssä.

YLÄRUNGON ASENNUS



OSA	NRO	Määrä
	8	2
	9	2
	11	2
	10L	1
	10R	1
	F1	

Asenna kukin yläpalkki kuvan mukaisesti ja kiinnitä ne ruuveilla ja aluslaatoilla (F1).

TUKIRAKENTEEN KOKOAMINEN 1

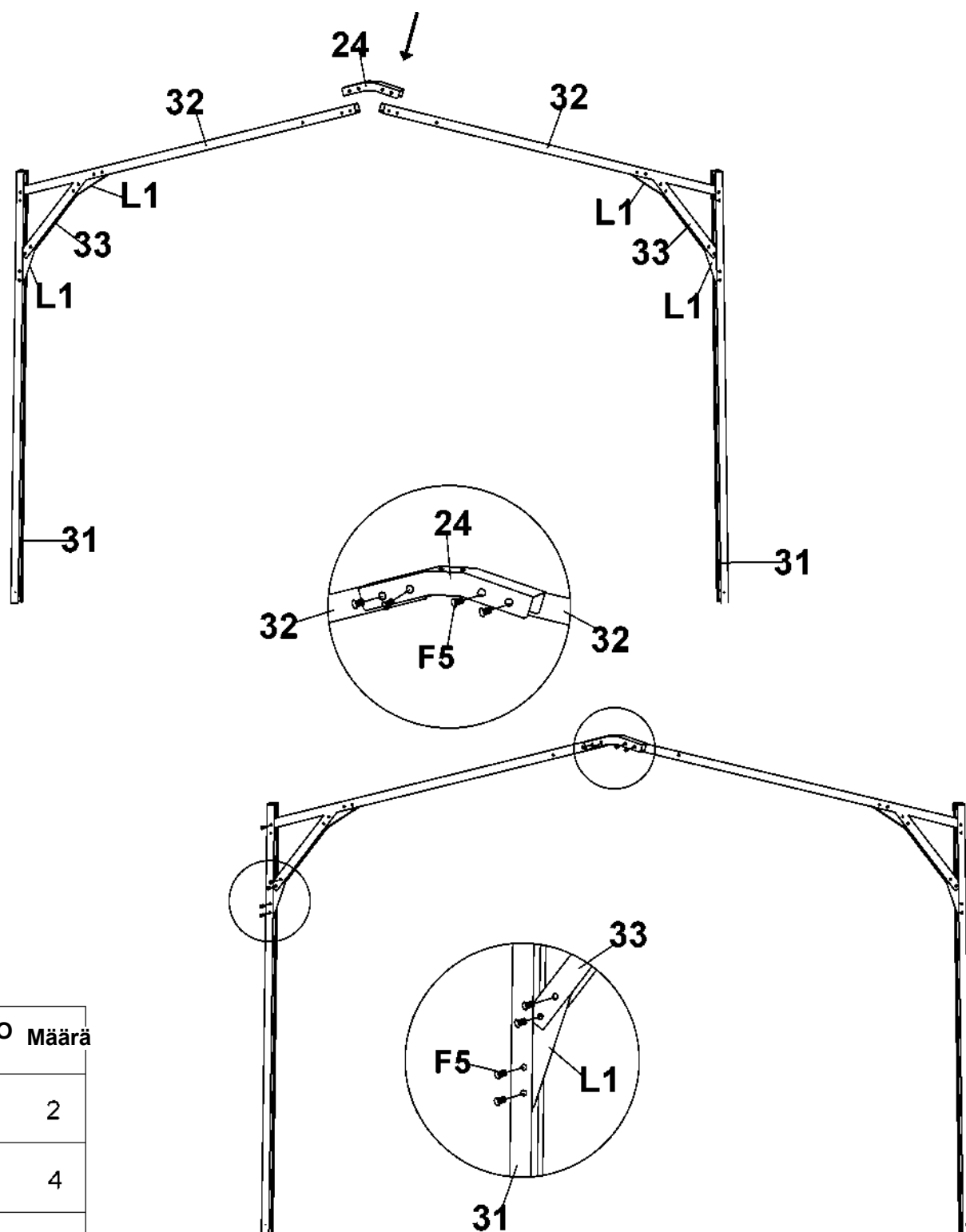

OSA	NRO	Määrä
	24	2
	31	4
	32	4
	33	4
	L1	16
	F5	

Ota esille kuvan osat ja kokoa tuennat yksitellen kuvan mukaisesti. Kiinnitä ruuveilla F5. Muista, että tukirakenteeseen kuuluu kaksi tukikehystä.

TUKIRAKENTEN KOKOAMINEN 2

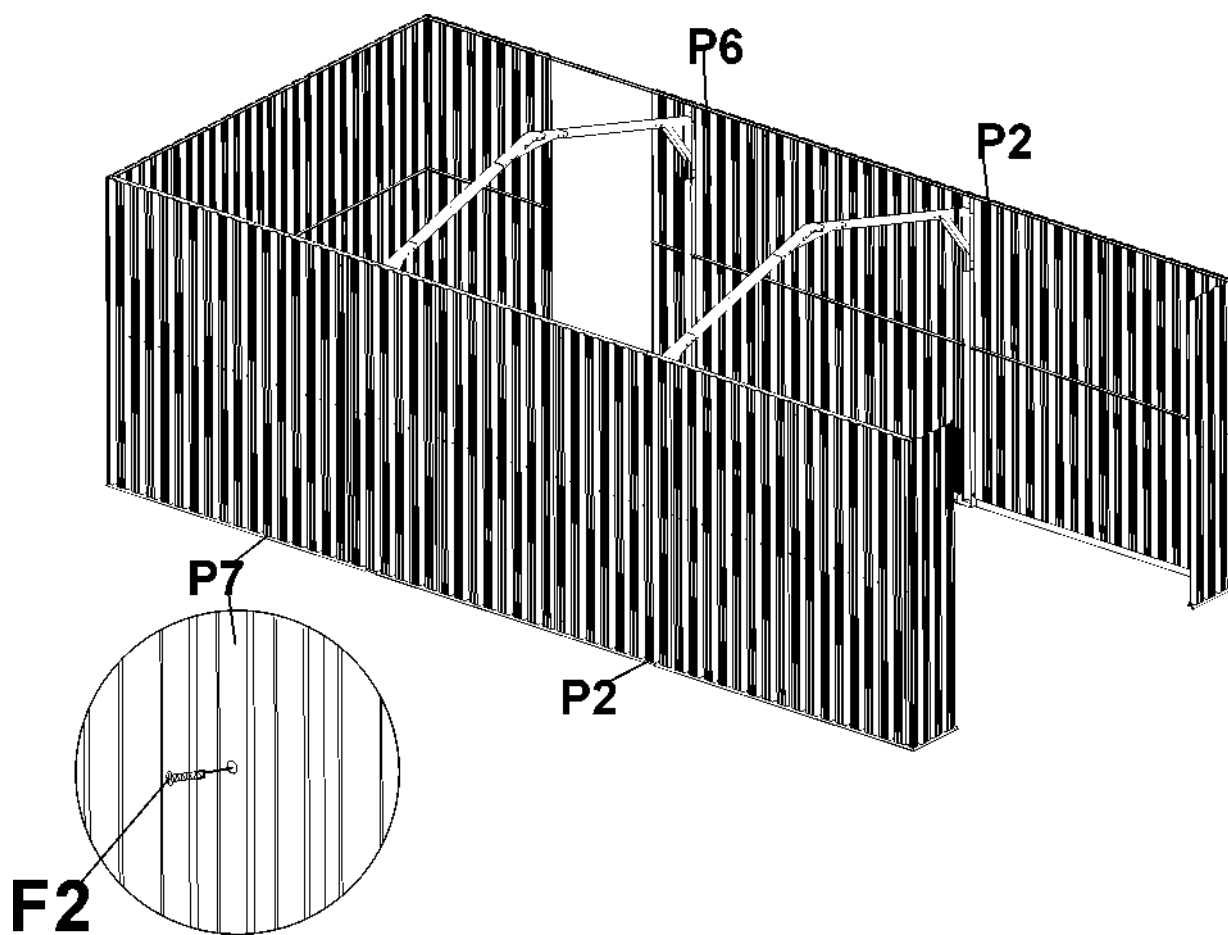

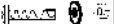
OSA	NRO	Määrä
	F2	

Asenna tukirakenne oikein (muista seinäasennuksessa mainittu 7–8 cm:n väli). Kiinnitä tukikehykset paneeleihin ruuveilla F2.

OVENKARMIN KOKOAMINEN

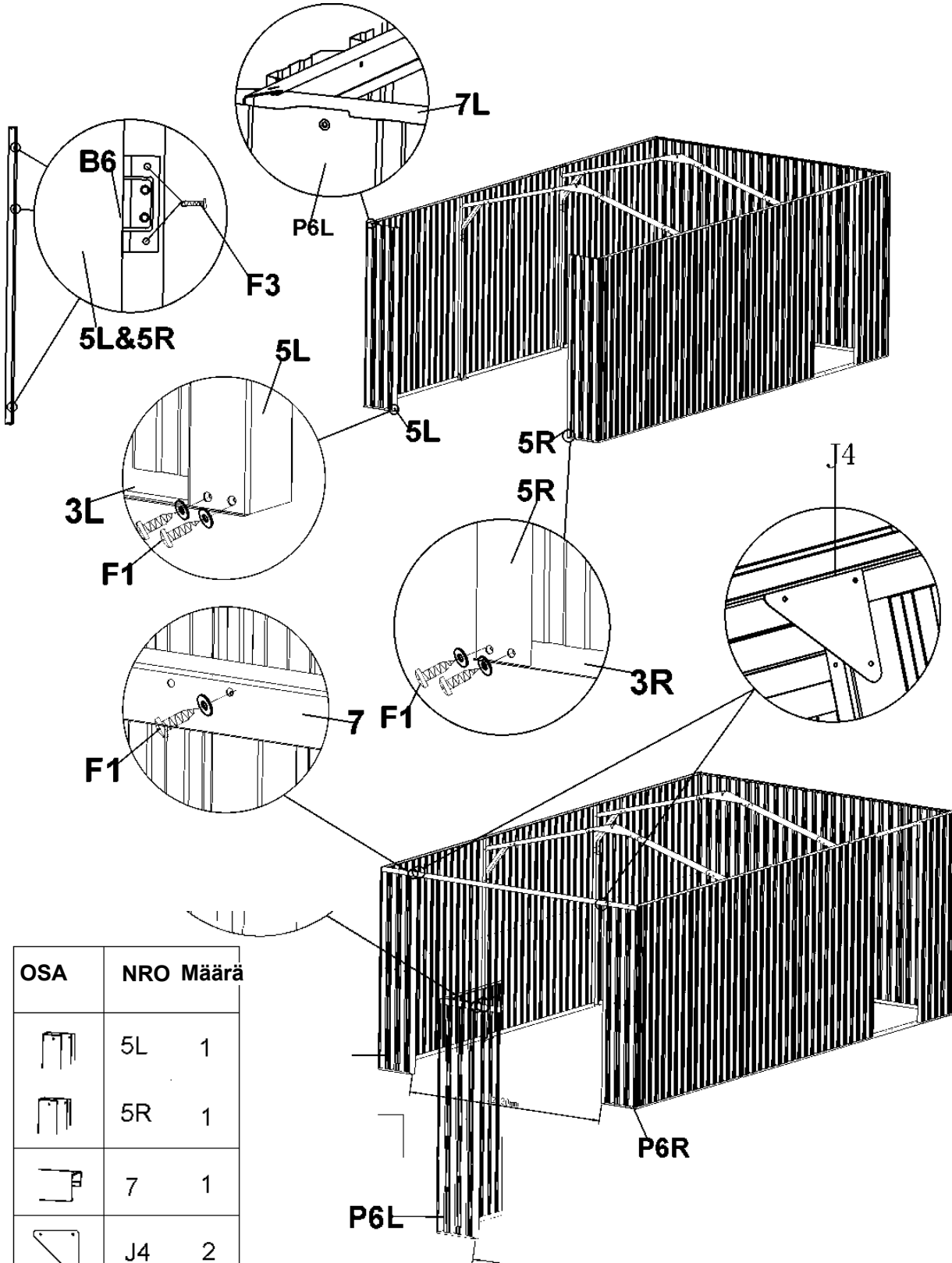

OSA	NRO Määrä		OSA	NRO	Määrä
	5L	1		5R	1
	7	1		B6	6
	J4	2		F3	
	7L	1			
	7R	1			
	F1				

PÄÄTYKOLMIOIDEN ASENNUS

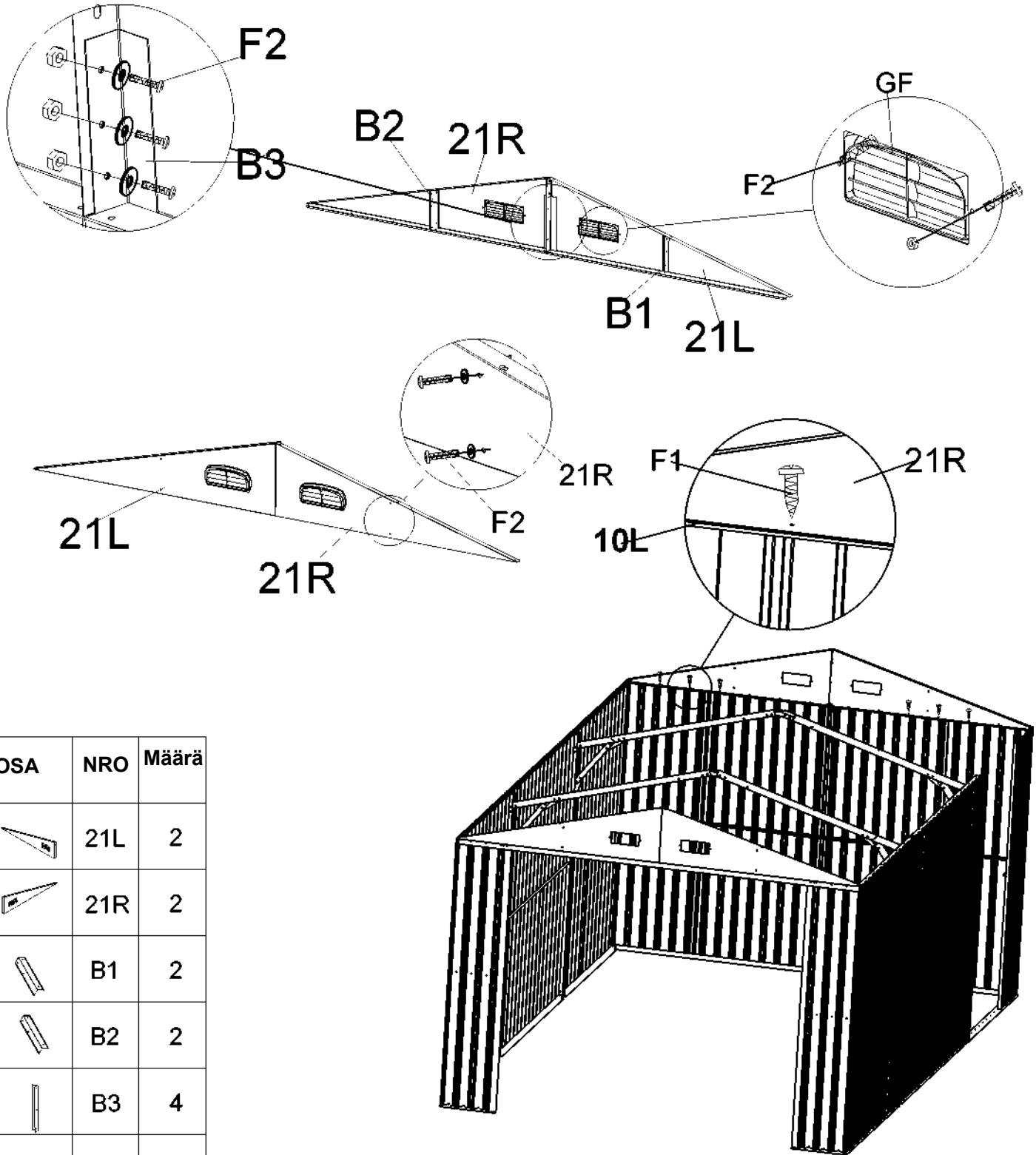

Huomaa: jokaiseen reikään tulee ruuvi

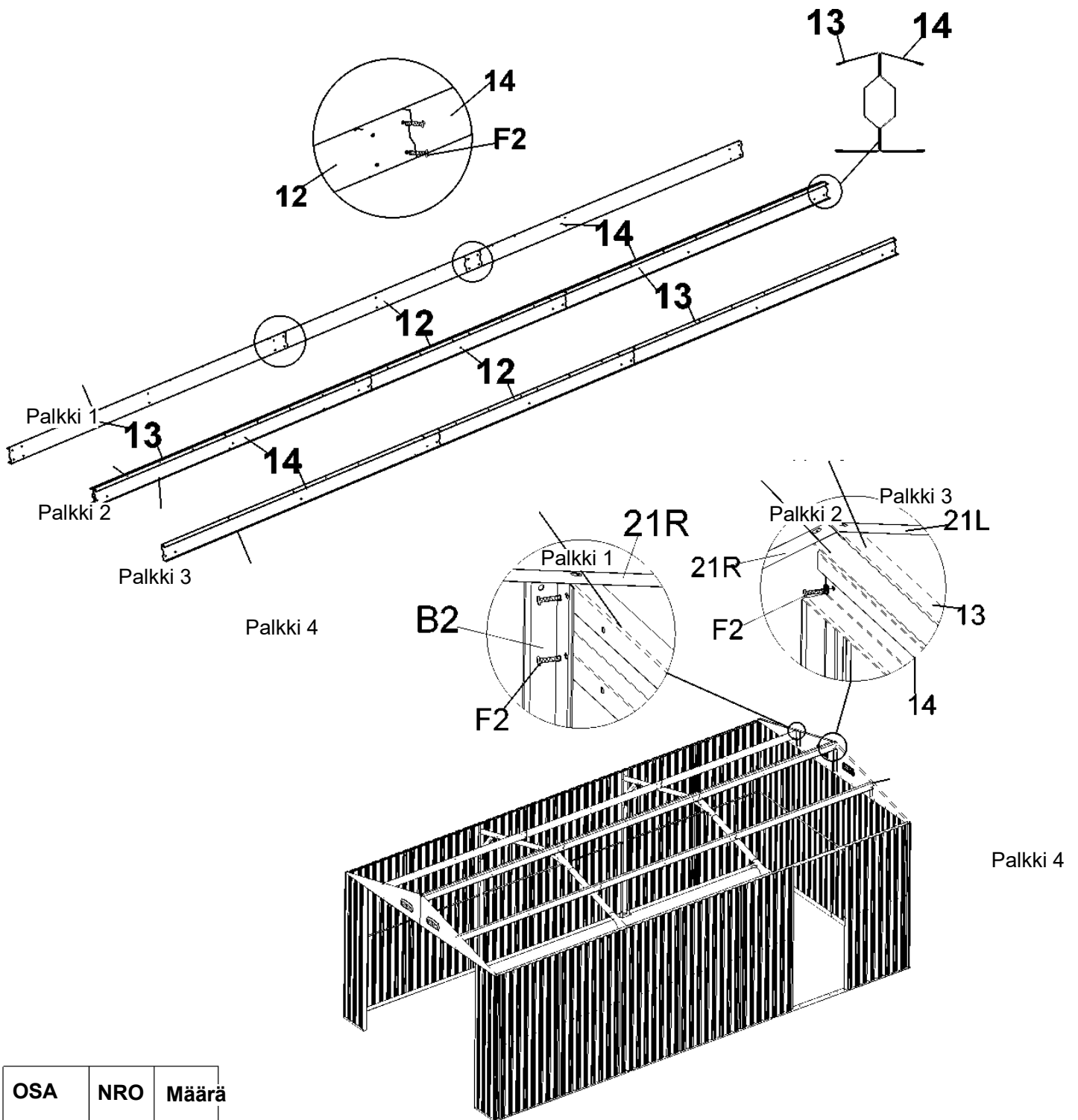

OSA	NRO	Määrä
	21L	2
	21R	2
	B1	2
	B2	2
	B3	4
	GF	4
	F1	
	F2	

OVENKARMIN KOKOAMINEN

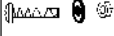

OSA	NRO	Määrä
	12	4
	13	4
	14	4
	F2	

YLÄPALKKIN VAHVISTAMINEN 1

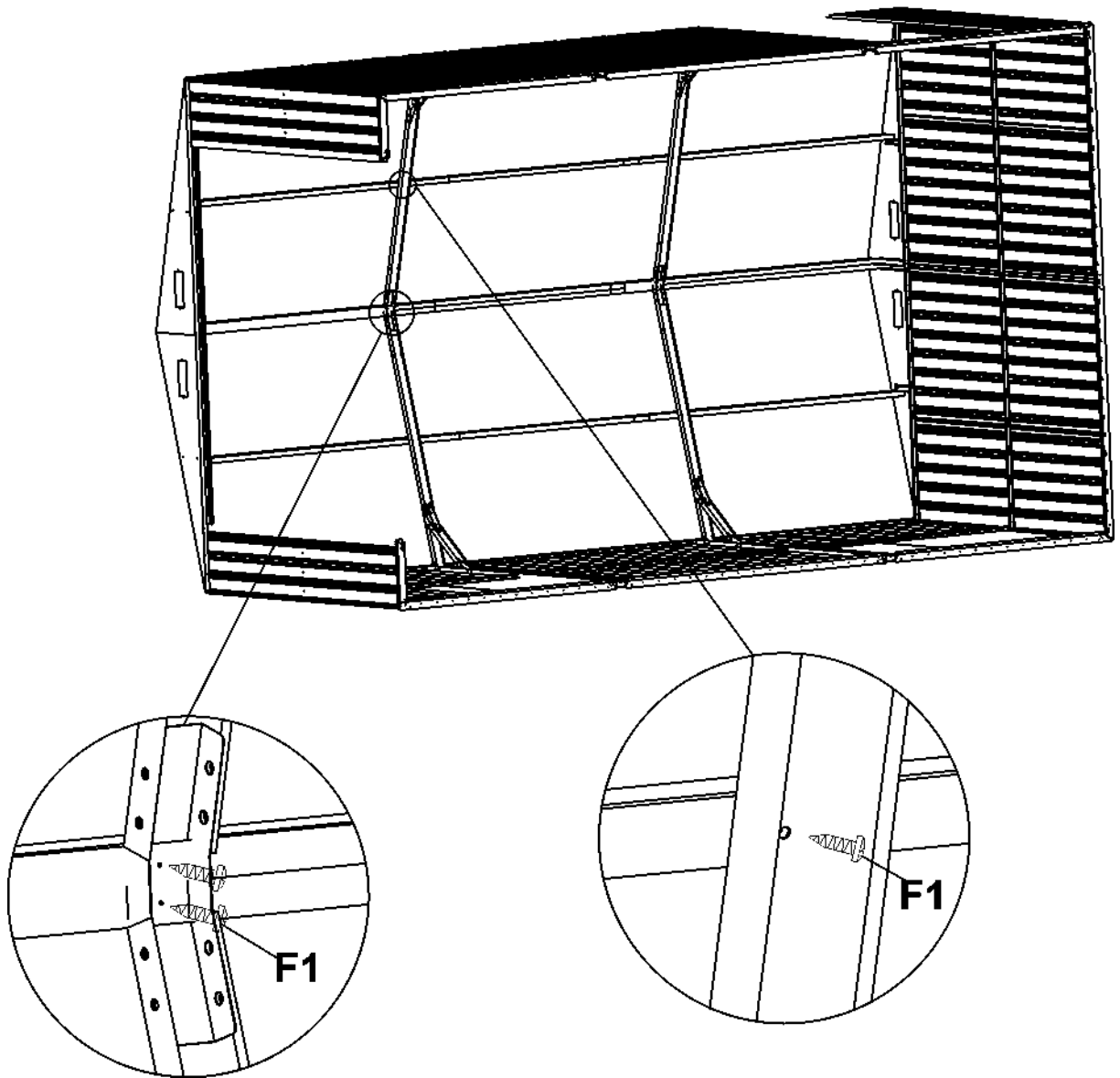

↖ YLÄOSA

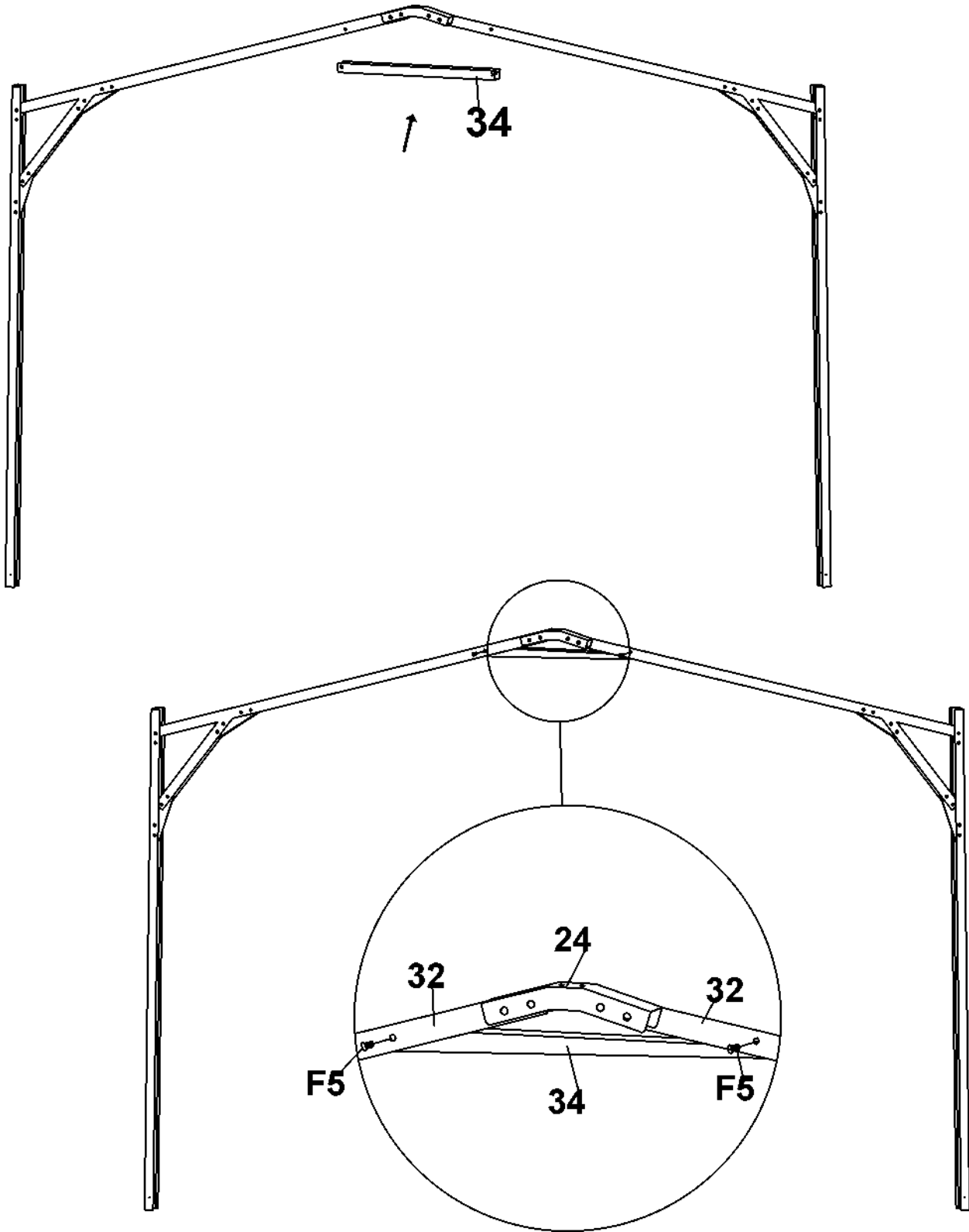

OSA	NRO	Määrä
	F1	

YLÄPALKKIN VAHVISTAMINEN 2





OSA	NRO	Määrä
	34	2
	F5	

KATTOPANEELIEN ASENNUS

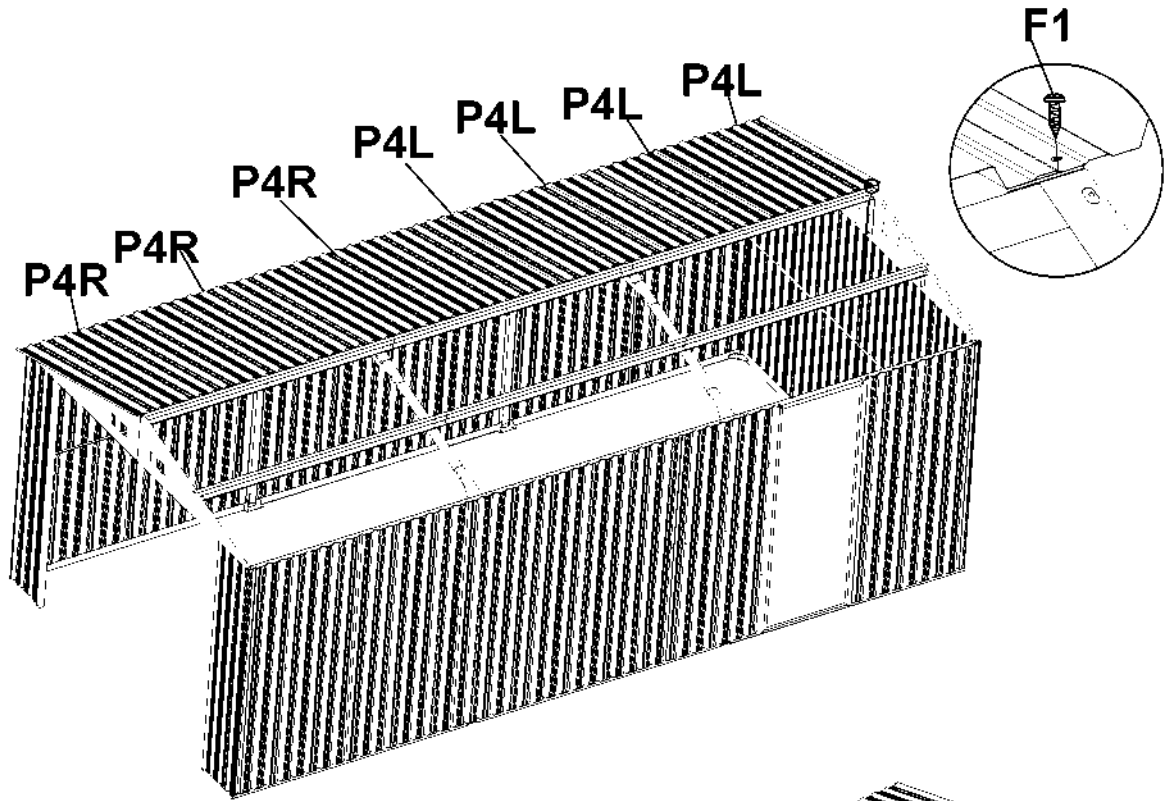
Huomaa: jokaiseen paneelin reikään tulee ruuvi.



OSA	NRO	Määrä
	P4L	8
	P4R	6
	F1	

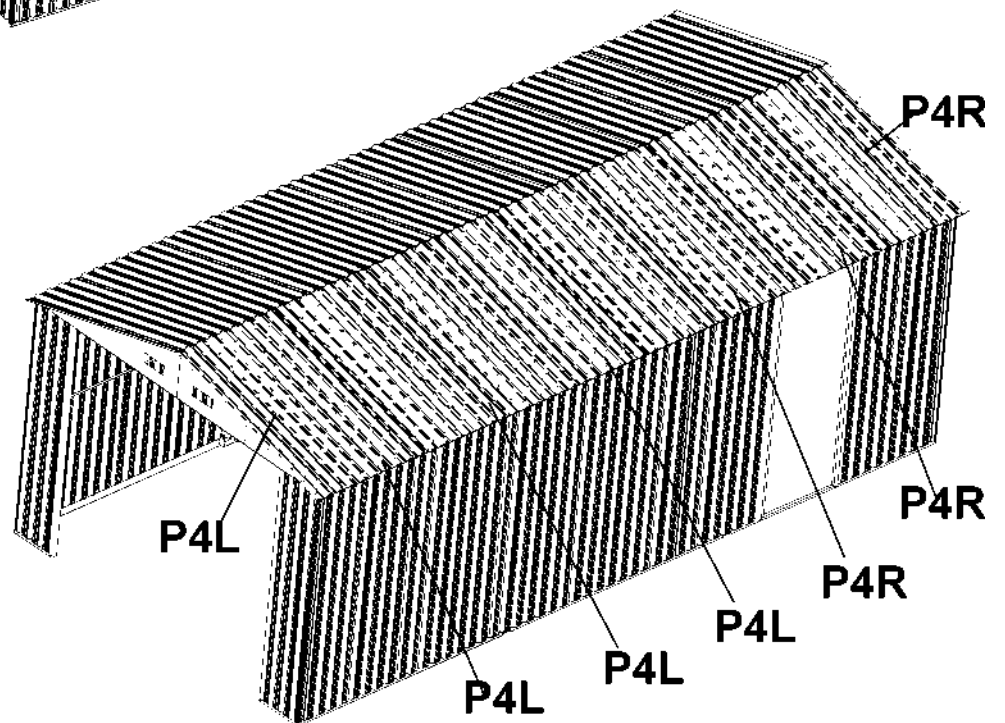



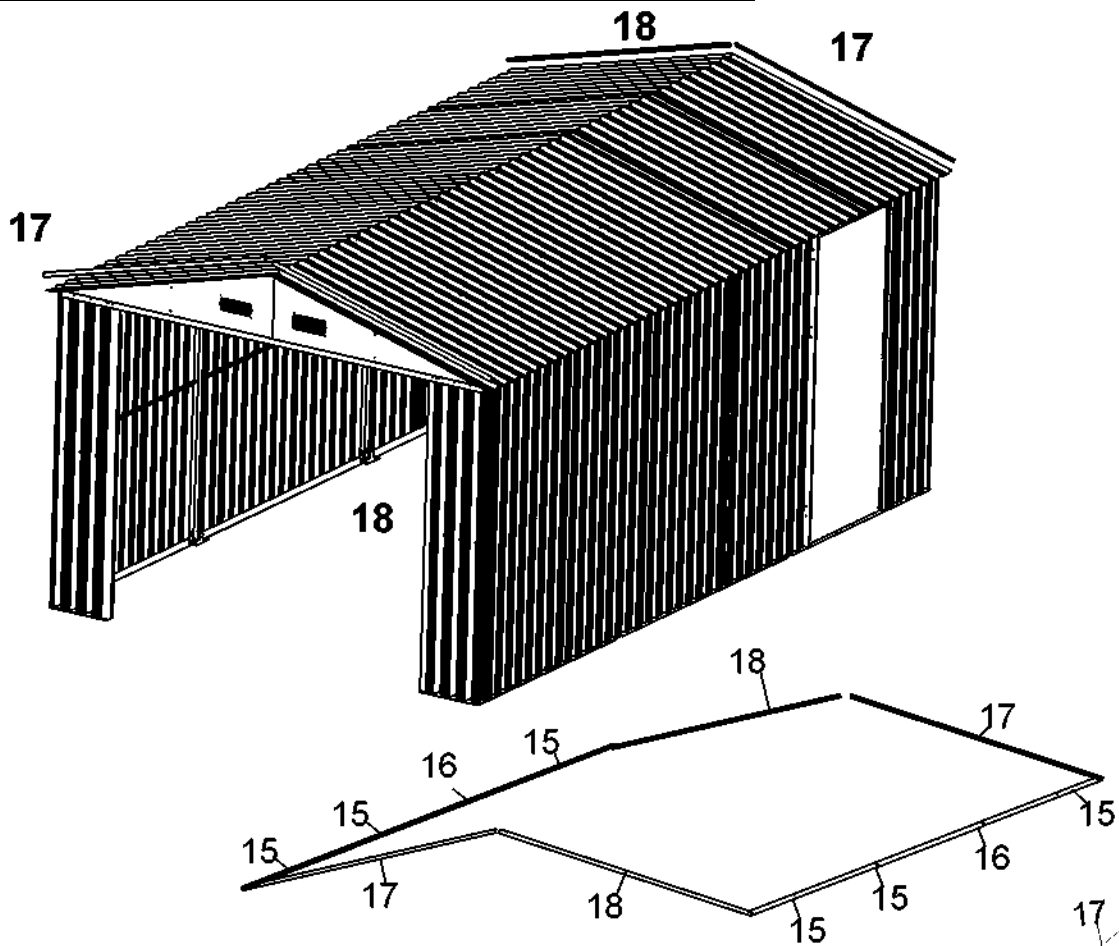

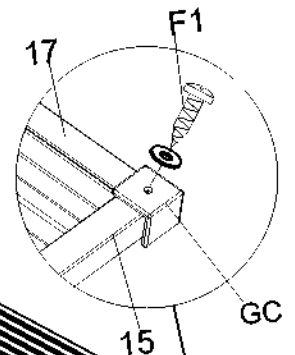
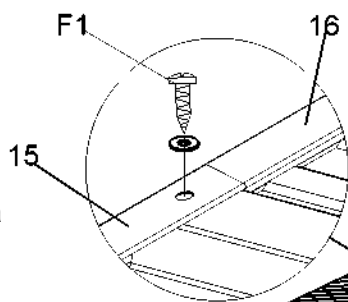

REUNAPELLITYKSEN ASENNUS



Huomaa: jokaiseen ruuvipellin reikään tulee ruuvi.



OSA	NRO	Määrä
	15	6
	16	2
	17	2
	18	2
	GC	4
	F1	

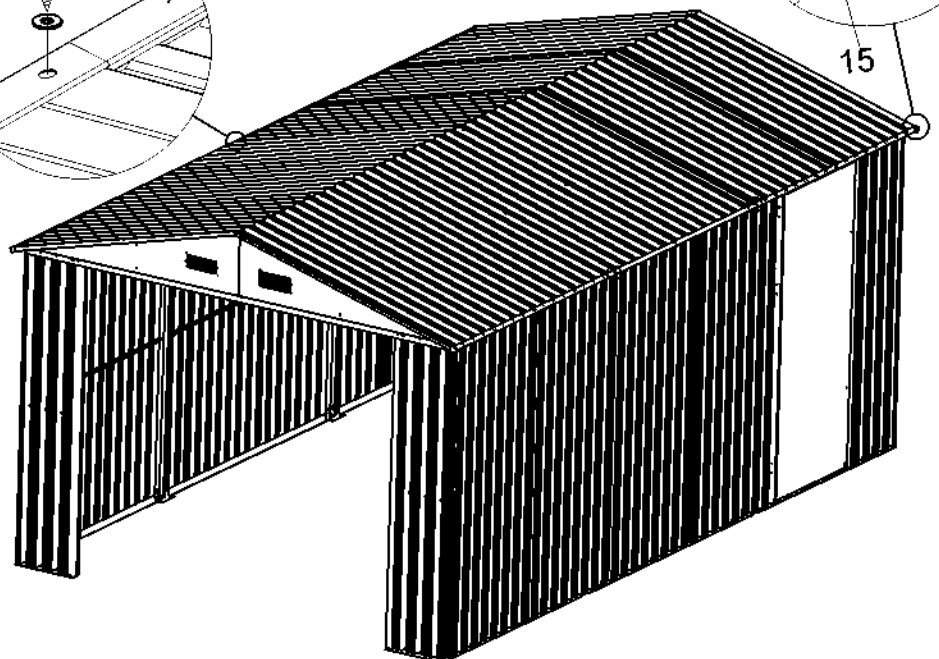

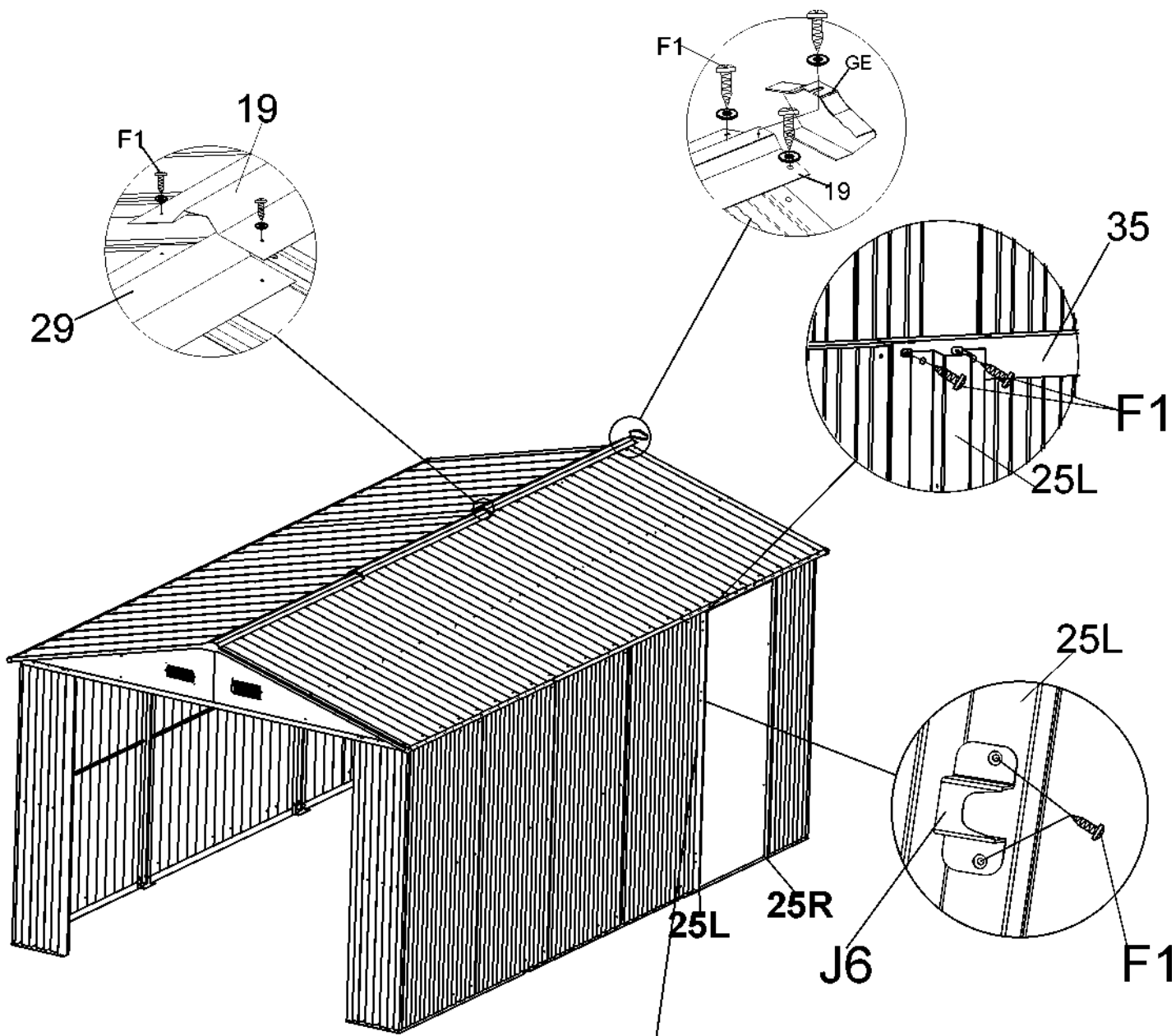



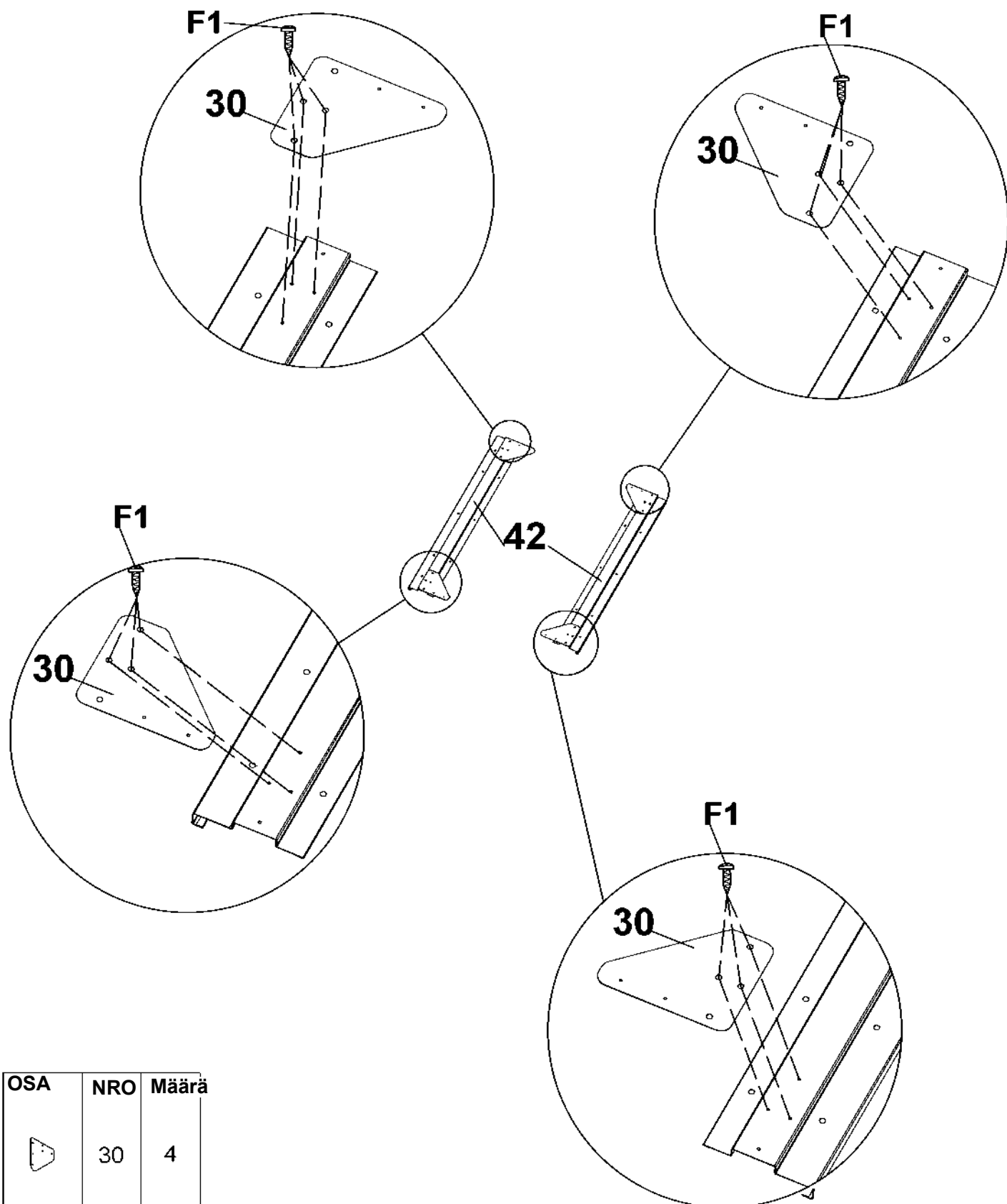

OSA	NRO	Määrä
	19	7
	GE	2
	F1	
	25L	1
	25R	1
	F2	1
	J6	1

OSA	NRO	Määrä
	35	1

OVEN ASENNUS 1





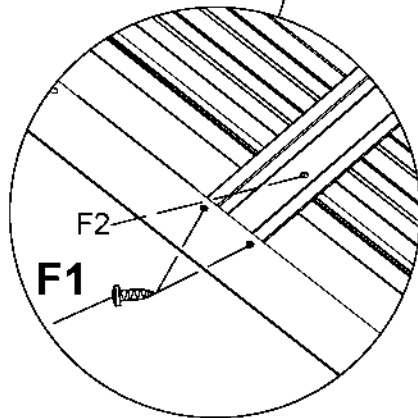
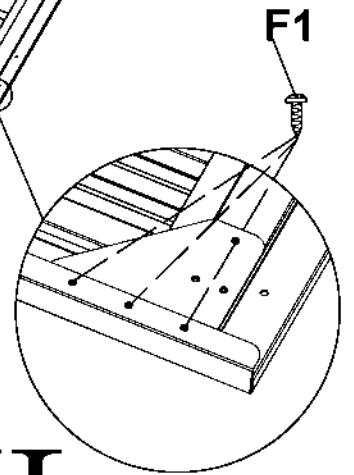
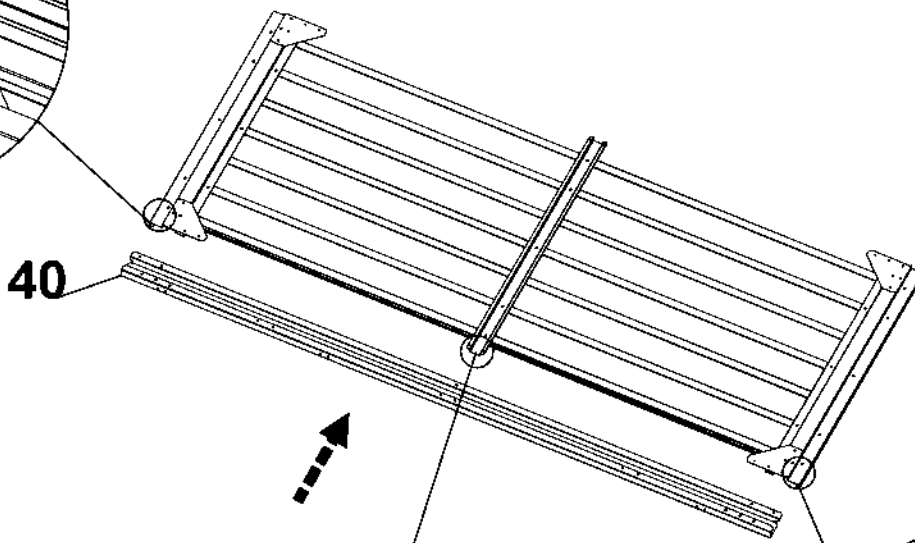
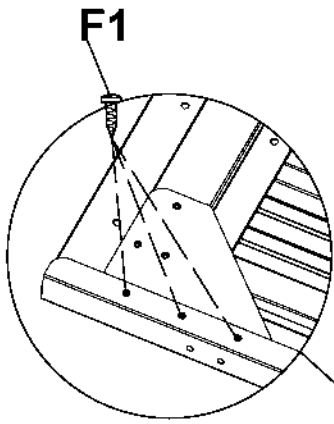
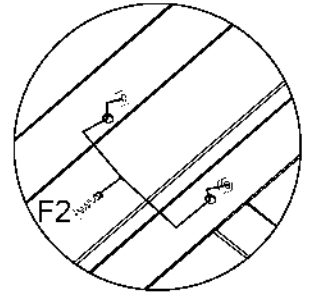
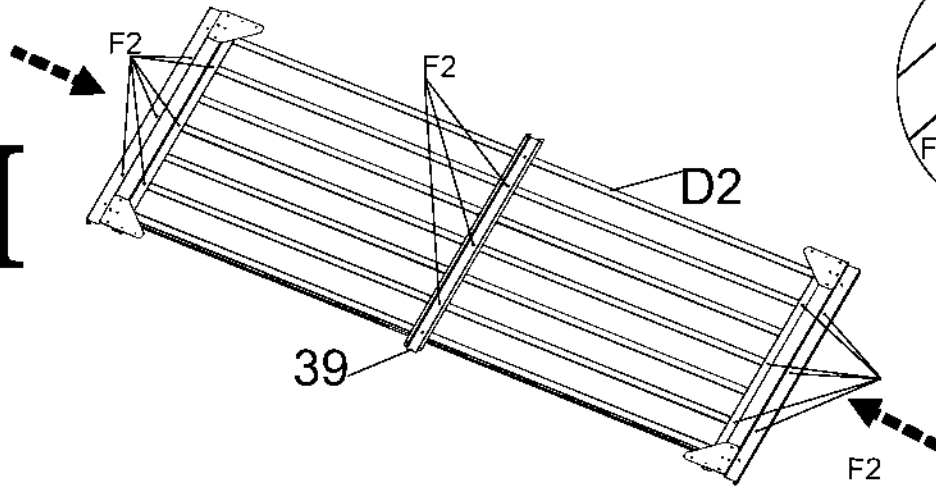

OSA	NRO	Määrä
	30	4
	42	2
	F1	

OVEN ASENNUS 2

I







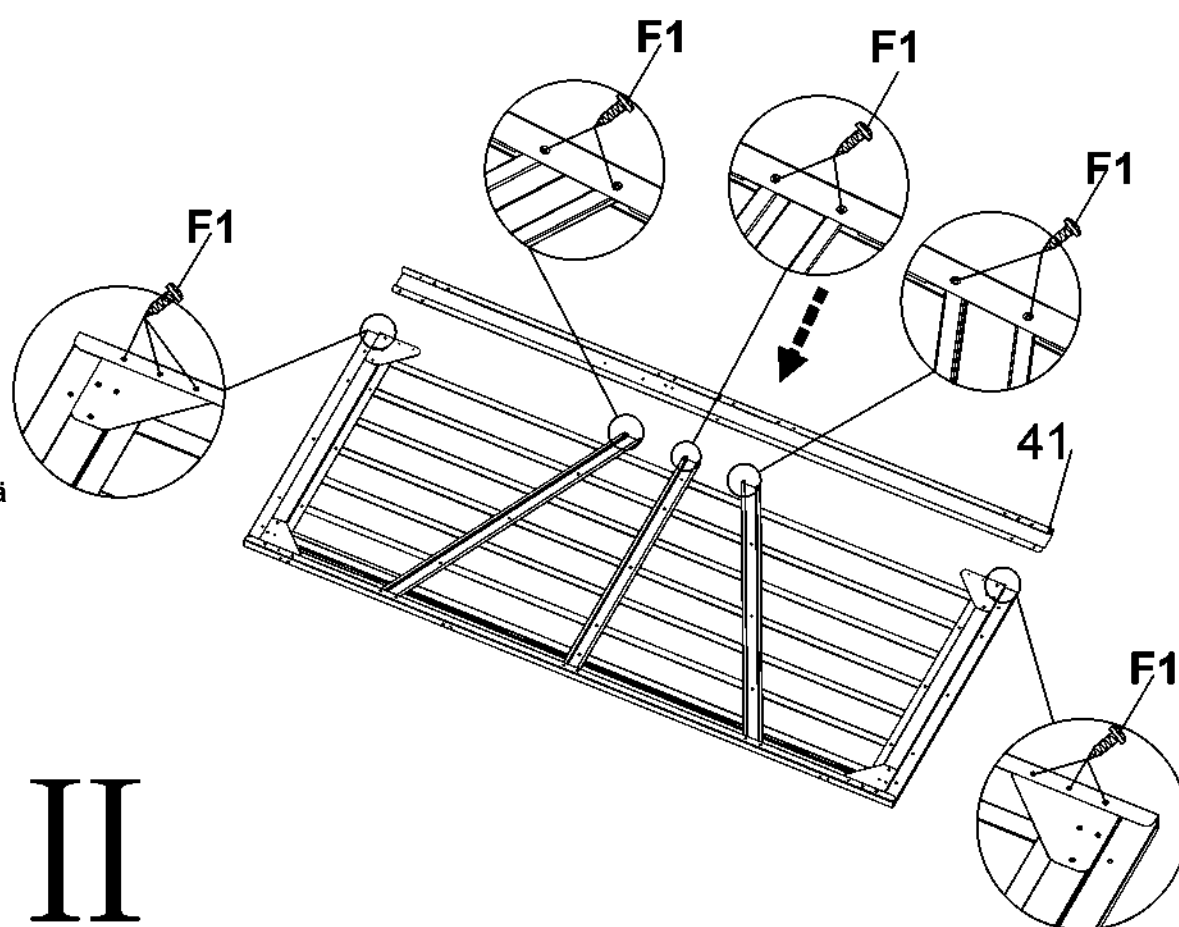
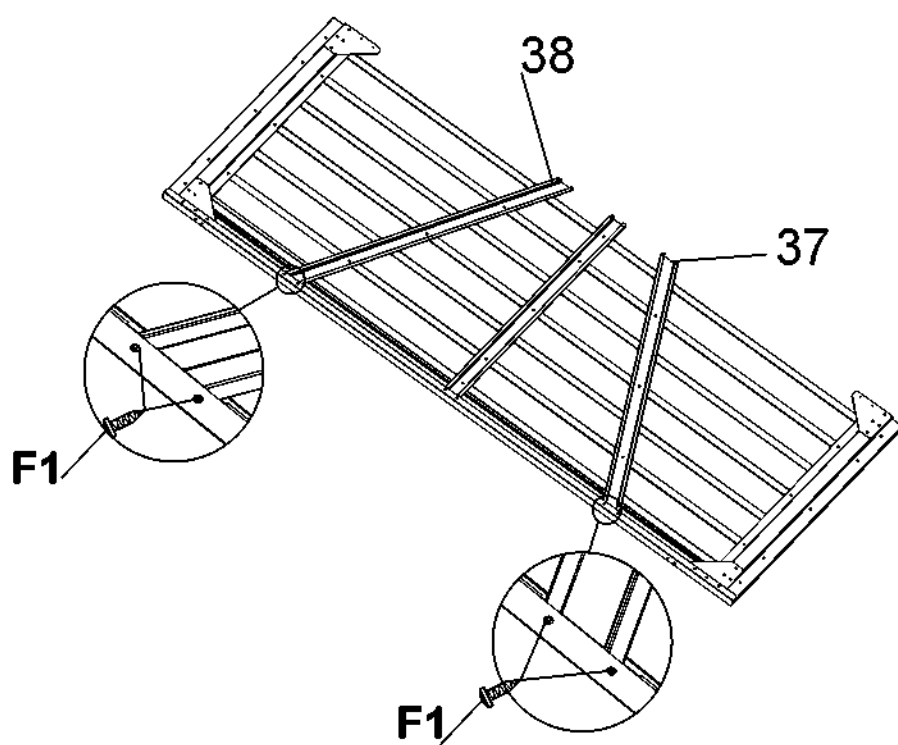

II

OSA	NRO	Määrä
	40	1
	39	1
	D2	1
	F2	
	F1	

OVEN ASENNUS 3

I



OSA	NRO	Määrä
	37	1
	38	1
	41	1
	F2	
	F1	

II

OVEN ASENNUS 4

I

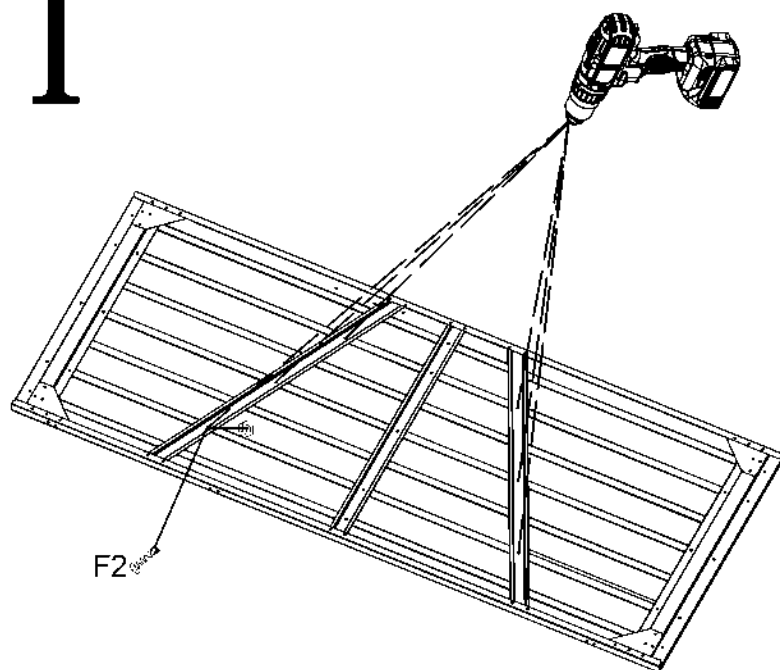



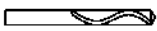

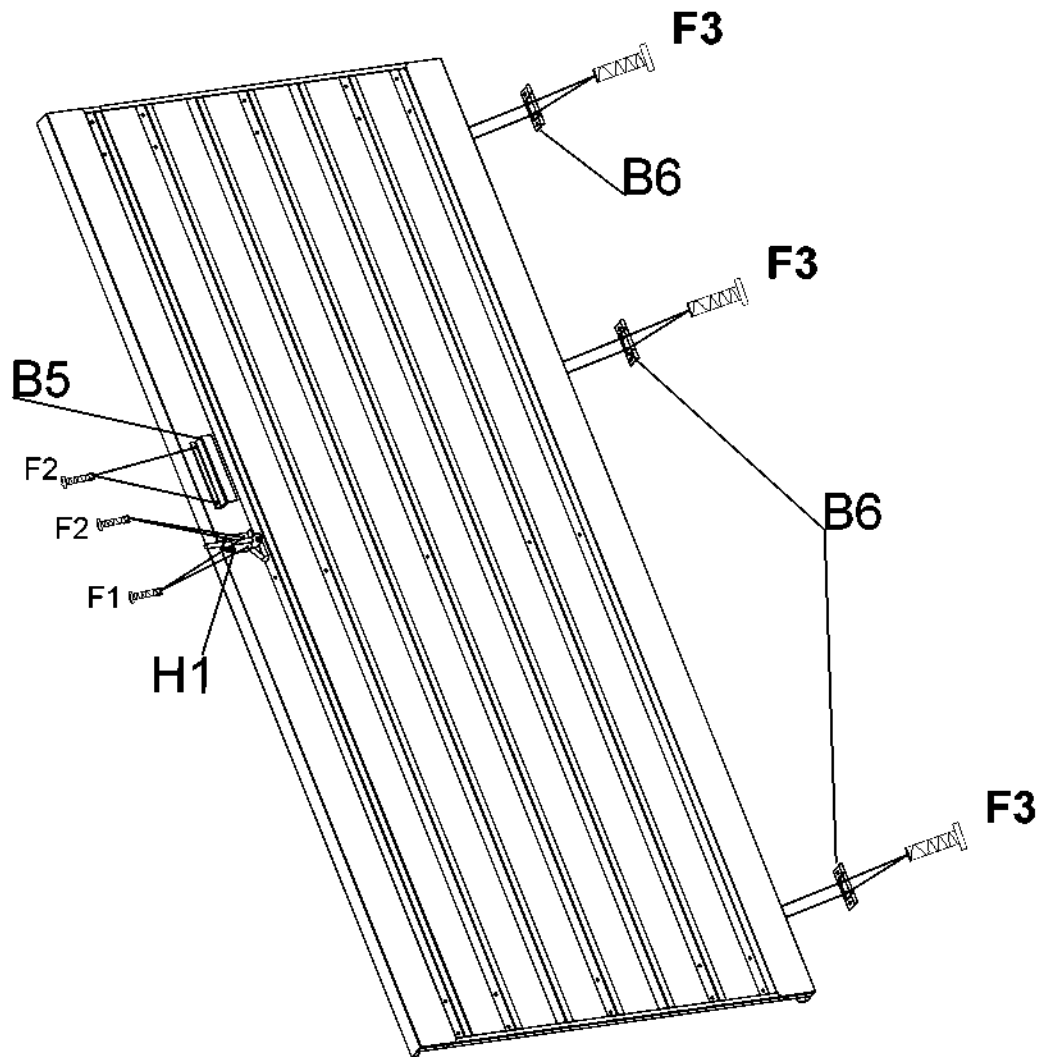

II

OSA	NRO	Määrä
	F2	
		

OVEN ASENNUS 5



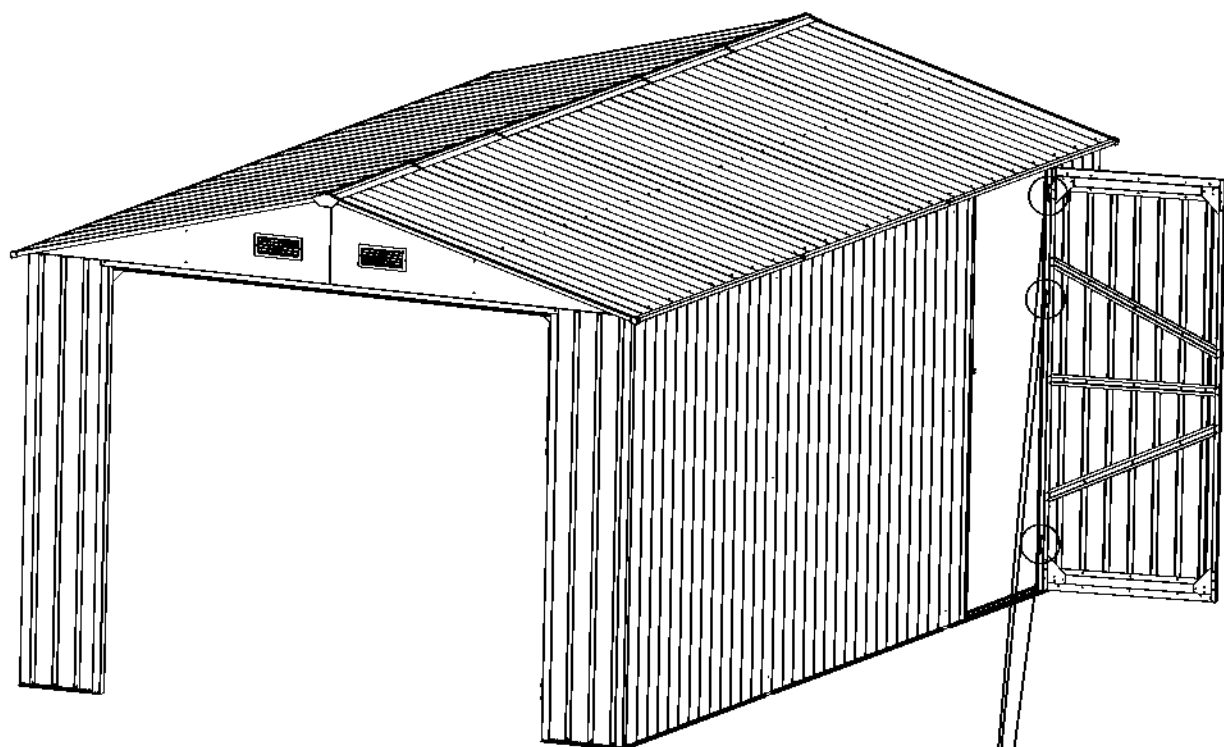

OSA	NRO	Määrä
	B5	1
	B6	3
	H1	1
	F3	
	F2	
	F1	

OVEN ASENNUS 6



F3

Hinnasto

OSA	NRO	Määrä
 	F3	

NOSTO-OVEN ASENNUS

Nosto-oven moottori

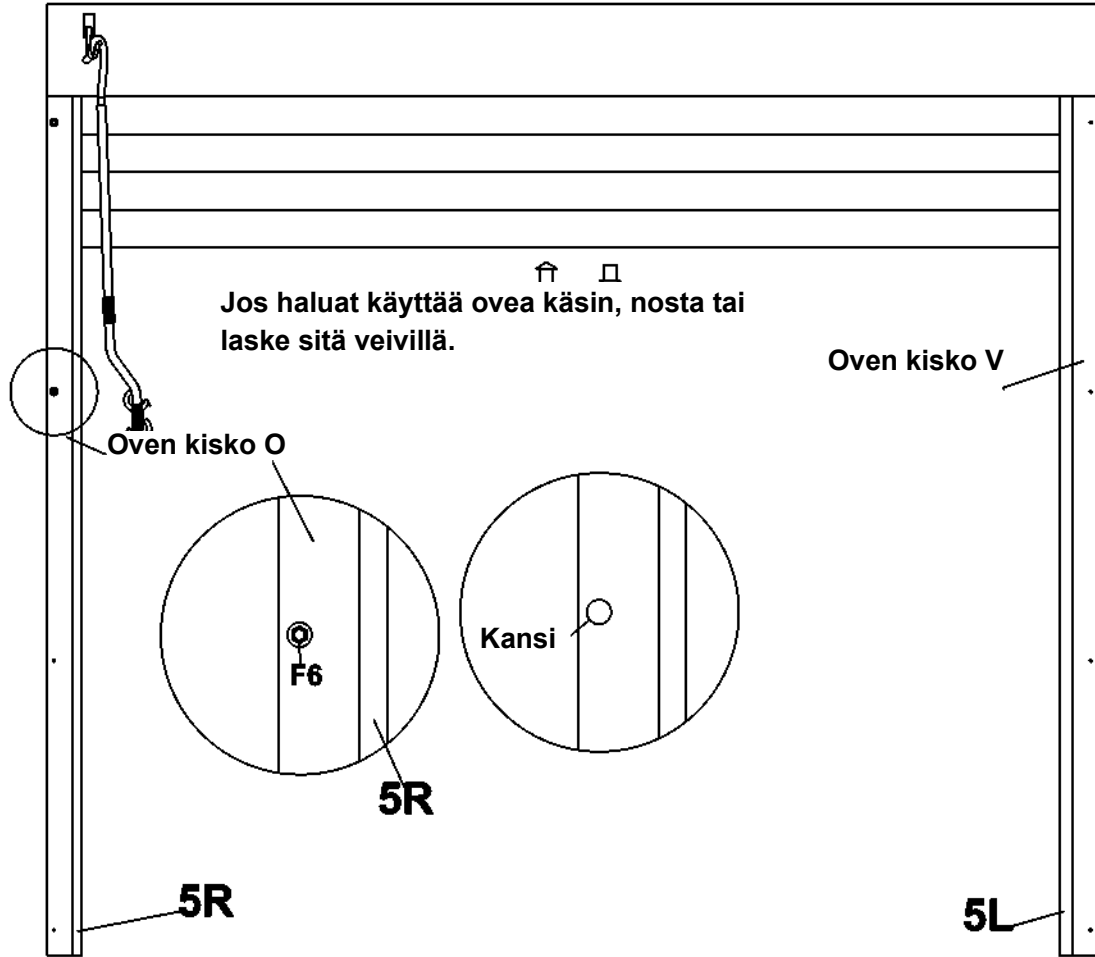

OSA	NRO	Määrä	Huomautus
	Nosto-oven moottori	1	väri valkoinen
	Oven kisko V	1	valkoinen runko 1820mm
	Oven kisko O	1	valkoinen runko 1820mm
	Kansi	8	valkoinen ympyrä
	F6	8	
	Oven veivi	1	

Ota oven osat esille pakkauksesta. Aseta nosto-ovi kiskoihin, nosta se ylös ja asenna se ovenkarmeihin 5L ja 5R osilla F6. Peitä lopuksi ruuvireiät.

TALLIN KIINNITTÄMINEN

Asentajan vastuulla on pitää huoli, että tallin ankkurointi on riittävä.

Varoitus: Valmistaja ei vastaa puutteellisesta ankkuroinnista johtuvista henkilö- tai omaisuusvahingoista riippumatta siitä, mikä taho ankkuroinnin on suorittanut.

HOITO JA YLLÄPITO

Viimeistely: Pitkäkestoisen viimeistelyn saat puhdistamalla ja vahaamalla ulkopinnat säännöllisesti. Korjaa naarmut heti, kun huomaat ne. Puhdista välittömästi kohta teräsharjalla, pese se ja lisää korjausmaalia valmistajan suositusten mukaisesti.

Katto: Pidä lehdet ja lumi poissa katolta pitkävartisella ja pehmeäharjaisella harjalla. Suuret lumimäärät katolla voi vaurioittaa tallia, jolloin sinne meneminen ei ole turvallista.

Ovet: Pidä ovenvälit puhtaina, jotta ne liikkuvat vaivatta. Voitele kisko vuosittain huonekalulakalla tai silikoniruiskeella. Pidä ovet suljettuina, jotta tuuli ei vaurioita niitä.

Kiinnikkeet: Käytä kaikkia aluslaattoja, sillä ne suojaavat veden läpäisyltä ja metallia ruuvien aiheuttamilta naarmuilta. Tarkasta talli säännöllisesti löysien ruuvien, pulttien, muutereiden jne. varalta, ja kiristä ne tarvittaessa.

Kosteus: Koko lattian alueelle asetettava hörynsulku ja hyvä ilmanvaihto vähentävät kondenssin muodostumista.

Muita vinkkejä

Pese osanumerot pois paneeleista saippuavedellä.

Saumat voidaan tiivistää silikonilla.

Älä säilytä uima-allaskemikaaleja tallissa. Säilytä syttyvät ja syövyttävät aineet ilmatiiviissä, asianmukaisissa astioissa.