



# LA PLAYA DRY BAGS

Resistant beyond time

**LaPLAYA**®  
Outdoor products





# LaPLAYA® Dry Bags

## Introduction

A new line of weatherproof and waterproof bags designed for the ultimate outdoor experience.

LaPLAYA® Dry bags are featured by functional and minimal design, durable material and high quality construction technology; therefore all our products are the perfect partner for active travellers, outdoor and sport activities and ultimate all-weather adventure.

Whether you're looking for a waterproof Jumbo duffel for your sailing days or an urban-styled weatherproof messenger, with LaPLAYA® you can find it.

All our bags are designed and built with attention to materials and technological processes, because our products are resistant beyond time!

## Einführung

Die neue Taschen Serie, LaPLAYA® Dry Bags, inspiriert von genialer Funktionalität, ist der perfekte Begleiter für den aktiven, sportlichen Outdoor Traveller.

Die neue Dry Bag Linie, ist attraktiv im Design mit einer hohen Funktionalität, schmutzabweisend und hält jedem Wetter stand.

Ihre individuellen Modelle sind maßgeschneidert für den Aktivurlaub, für ultimative Abenteuer und ganz allgemein für Sport und Freizeit.

Ein breites Programm, das unterschiedlichste Outdoor-Anforderungen erfüllt - von der wasserdichten Jumbo Duffel Tasche für stürmische Zeiten bis hin zur wetterfesten Ausführung im Urban Style für den Stadtbummel.

Die neuen Dry Bags bestechen durch hochwertige Materialien und robuste Konstruktion. "Go Beyond Time" mit den Produkten von LaPLAYA®!

## Introduction

La nouvelle ligne de sacs imperméables, résistants à l'eau et aux intempéries, a été spécialement conçue pour vos expériences loisirs ou sportives extrêmes en plein-air.

Les sacs imperméables LaPLAYA® Dry bags se distinguent par un design optimal et fonctionnel, par la solidité du matériau et par la grande qualité de la technique de leur fabrication. Tous les produits LaPLAYA® Dry bags sont, de ce fait, le partenaire idéal pour les grands voyageurs, pour ceux pratiquant des activités de loisirs ou sportives extrêmes en plein-air, en un mot pour les aventuriers extrêmes par tout temps.

Vous êtes à la recherche d'un sac imperméable pour vos activités en extérieur ou pour la ville, chez LaPLAYA®, vous le trouverez.

Tous les sacs LaPLAYA® Dry bags ont été conçus et fabriqués avec une attention particulière pour la qualité des matériaux et des techniques de fabrication, car tous nos produits sont résistants au delà des temps!

# index



Page 6

**Jumbo Duffel 120**



Page 8

**Cylinder Duffel 70**



Page 10

**Trolley Pack 60**



Page 12

**Trapeze Duffel 50**



Page 14

**Cylinder Sack 50**



Page 16

**Square Bag 40**



Page 18

**Back Pack 20**



Page 20

**Messenger Bag 10**

**Bags built for  
cool moving people**



## Jumbo Duffel 120

- XXL thermowelded bag
- water resistant zippers
- easy access top compartment
- outer and inner pockets
- reflective bindings on handles
- detachable shoulder strap

- thermogeschweißte XXL Tasche
- wasserabweisende Reißverschlüsse
- leicht zugängliches Fach auf der Oberseite
- Innen- und Außentaschen
- Tragegriffe mit reflektierendem Band
- abnehmbarer Schultertragegurt

- sac imperméable XXL soudé
- fermetures éclair résistantes à l'eau
- compartiment ouvrable sur le dessus
- pochettes intérieures et extérieures
- bandes réfléchissantes sur les poignées
- bandoulière détachable



6



left side

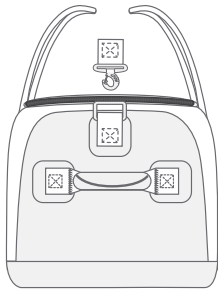

front

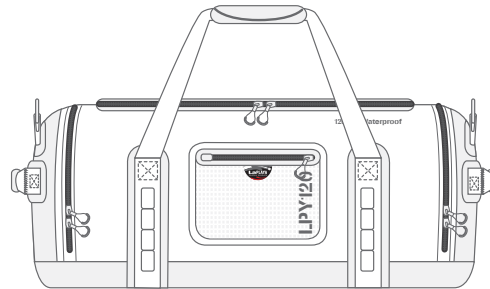

right side

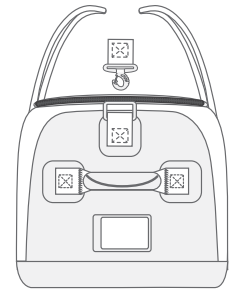

top

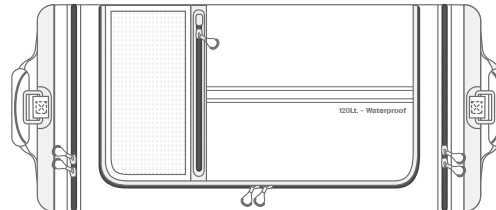

## FEATURES

Volume: 120 Lt

Dimension: 85 x 35 x 40 cm (W x H x D)

Material: PVC 500D Tarpaulin  
PVC mesh transparent

Colors:

- black/silver    Art. 800600
- black/black    Art. 800601
- black/white    Art. 800602

## MERKMALE

Volumen: 120 Liter

Abmessungen: 85 x 35 x 40 cm (B x H x T)

Material: PVC 500D Tarpaulin  
PVC Netz transparent

Farben:

- schwarz/silber    Art. 800600
- schwarz/schwarz    Art. 800601
- schwarz/weiß    Art. 800602

## CARACTÉRISTIQUES

Volume: 120 L

Dimensions: 85 x 40 x 35 cm (L x l x h)

Matériau: PVC 500D Tarpaulin  
PVC mesh transparent

Couleur:

- noir/argent    Art. 800600
- noir/noir    Art. 800601
- noir/blanc    Art. 800602

## Cylinder Duffel 70

- cylindric, thermowelded bag
- water resistant zippers
- spacious compartment
- outer and inner pockets
- reflective bindings on handles
- detachable shoulder strap

- thermogeschweißte, zylindrische Tasche
- wasserabweisende Reißverschlüsse
- großzügiges Aufbewahrungsfach
- Innen- und Außentaschen
- Tragegriffe mit reflektierendem Band
- abnehmbarer Schultertragegurt

- sac imperméable soudé cylindrique
- fermetures éclair résistantes à l'eau
- compartiment de rangement spacieux
- pochettes intérieures et extérieures
- bandes réfléchissantes sur les poignées
- bandoulière détachable



8



left side

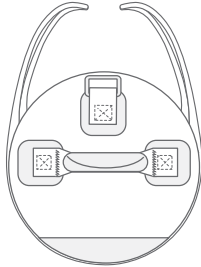

front

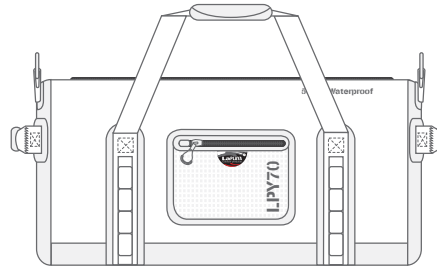

right side

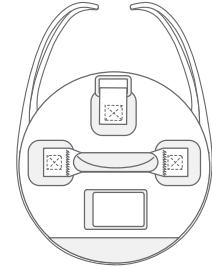

top

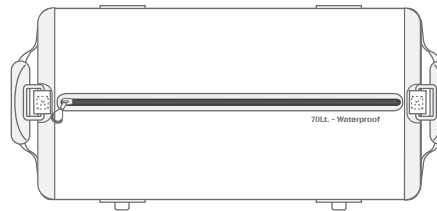



## FEATURES

Volume: 70 Lt

Size: 77 x 34 cm (W x D)

Material: PVC 500D Tarpaulin  
PVC mesh transparent

Colors:

	black/silver	Art. 800500
	black/black	Art. 800501
	black/white	Art. 800502



## MERKMALE

Volumen: 70 Liter

Abmessungen: 77 x 34 cm (B x Ø)

Material: PVC 500D Tarpaulin  
PVC Netz transparent

Farben:

	schwarz/silber	Art. 800500
	schwarz/schwarz	Art. 800501
	schwarz/weiß	Art. 800502



## CARACTÉRISTIQUES

Volume: 70 L

Dimensions: 77 x 34 cm (L x Ø)

Matériau: PVC 500D Tarpaulin  
PVC mesh transparent

Couleur:

	noir/argent	Art. 800500
	noir/noir	Art. 800501
	noir/blanc	Art. 800502

## Trolley Pack 60

- compact, thermowelded trolley bag
- water resistant zippers
- spacious compartment
- outer and inner pockets
- telescopic handle
- shoulder straps on back panel

- thermogeschweißter Trolley
- wasserabweisende Reißverschlüsse
- großzügiges Aufbewahrungsfach
- Innen- und Außentaschen
- Teleskopgriff
- Schultergurte auf der Rückseite

- sac Trolley imperméable soudé trapézoïdal
- fermetures éclair résistantes à l'eau
- compartiment ouvrable surle dessus
- pochettes intérieures et extérieures
- poignée de traction télescopique
- bretelles sur le panneau arrière



left side

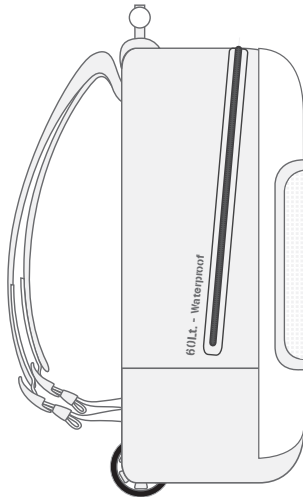

front



rear

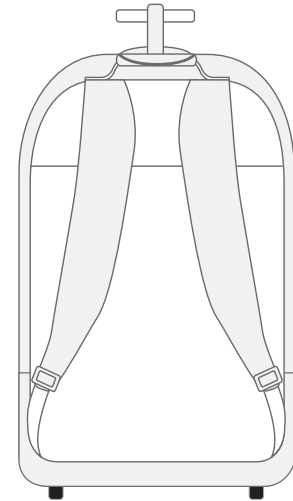

## FEATURES

Volume: 60 Lt

Size: 42 x 61 x 30 cm (W x H x D)

Material: PVC 500D Tarpaulin  
PVC mesh transparent

Colors:

- black/silver    Art. 800700
- black/black    Art. 800701
- black/white    Art. 800702

## MERKMALE

Volumen: 60 Liter

Abmessungen: 42 x 61 x 30 cm (B x H x T)

Material: PVC 500D Tarpaulin  
PVC Netz transparent

Farben:

- schwarz/silber    Art. 800700
- schwarz/schwarz    Art. 800701
- schwarz/weiß    Art. 800702

## CARACTÉRISTIQUES

Volume: 60 L

Dimensions: 42 x 30 x 61 cm (L x l x h)

Matériau: PVC 500D Tarpaulin  
PVC mesh transparent

Couleur:

- noir/argent    Art. 800700
- noir/noir    Art. 800701
- noir/blanc    Art. 800702

## Trapeze Duffel 50

- trapezoidal, thermowelded bag
- water resistant zippers
- compact size
- outer and inner pockets
- reflective bindings on handles
- detachable shoulder strap

- thermogeschweißte Tasche in Trapezform
- wasserabweisende Reißverschlüsse
- kompakte Größe
- Innen- und Außentaschen
- Tragegriffe mit reflektierendem Band
- abnehmbarer Schultertragegurt

- sac imperméable soudé trapézoïdal
- fermetures éclair résistantes à l'eau
- compact
- pochettes intérieures et extérieures
- bandes réfléchissantes sur les poignées
- bandoulière détachable



left side

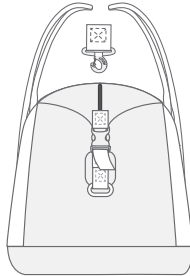

front



right side

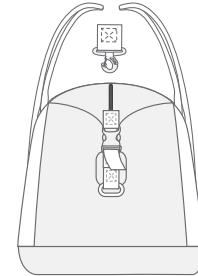

top

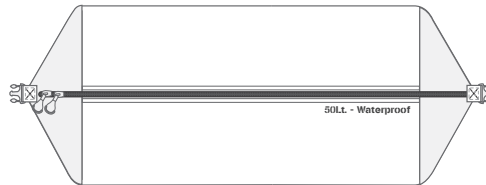



## FEATURES

Volume: 50 Lt

Size: 51 x 39 x 31 cm (W x H x D)

Material: PVC 500D Tarpaulin  
PVC mesh transparent

Colors:

	black/silver	Art. 800400
	black/black	Art. 800401
	black/white	Art. 800402



## MERKMALE

Volumen: 50 Liter

Abmessungen: 51 x 39 x 31 cm (B x H x T)

Material: PVC 500D Tarpaulin  
PVC Netz transparent

Farben:

	schwarz/silber	Art. 800400
	schwarz/schwarz	Art. 800401
	schwarz/weiß	Art. 800402



## CARACTÉRISTIQUES

Volume: 50 L

Dimensions: 51 x 31 x 39 cm (L x l x h)

Matériau: PVC 500D Tarpaulin  
PVC mesh transparent

Couleur:

	noir/argent	Art. 800400
	noir/noir	Art. 800401
	noir/blanc	Art. 800402

## Cylinder Sack 50

- thermowelded cylinder sack
- roll closer on top compartment
- water resistant zippers
- outer and inner pockets
- reflective bindings on handles
- detachable back shoulder straps

- thermogeschweißter Zylindersack
- Hauptfach mit Rollverschluss
- wasserabweisende Reißverschlüsse
- Innen- und Außentaschen
- Tragegriffe mit reflektierendem Band
- abnehmbarer Schultertragegurt

- sac imperméable soudé cylindrique
- à fermeture enroulable sur le dessus
- fermetures éclair résistantes à l'eau
- pochettes intérieures et extérieures
- bandes réfléchissantes sur les poignées
- bandoulière détachable



front

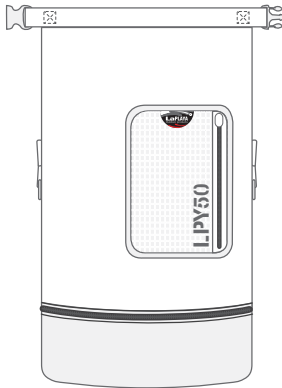

right side

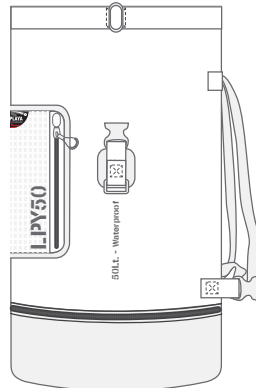

rear

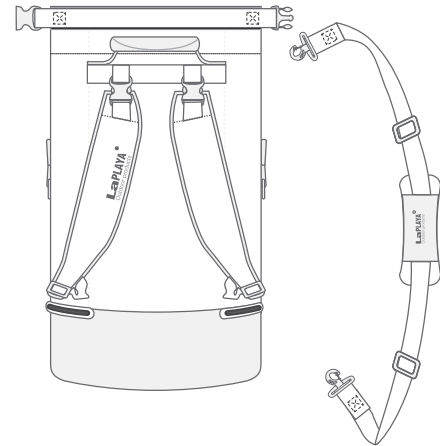



## FEATURES

Volume: 50 Lt

Size: 79 x 30 cm (H x D)

Material: PVC 500D Tarpaulin  
PVC mesh transparent

Colors:

	black/silver	Art. 800300
	black/black	Art. 800301
	black/white	Art. 800302



## MERKMALE

Volumen: 50 Liter

Abmessungen: 79 x 30 cm (H x Ø)

Material: PVC 500D Tarpaulin  
PVC Netz transparent

Farben:

	schwarz/silber	Art. 800300
	schwarz/schwarz	Art. 800301
	schwarz/weiß	Art. 800302



## CARACTÉRISTIQUES

Volume: 50 L

Dimensions: 79 x 30 cm (h x Ø)

Matériau: PVC 500D Tarpaulin  
PVC mesh transparent

Couleur:

	noir/argent	Art. 800300
	noir/noir	Art. 800301
	noir/blanc	Art. 800302

## Square Bag 40

- thermowelded square bag
- water resistant zippers
- outer and inner pockets
- reflective bindings on handles
- detachable shoulder straps

- quadratische, thermogeschweißte Tasche
- wasserabweisende Reißverschlüsse
- Innen- und Außentaschen
- Tragegriffe mit reflektierendem Band
- abnehmbarer Schultertragegurt

- sac imperméable soudé carré
- fermetures éclair résistantes à l'eau
- pochettes intérieures et extérieures
- bandes réfléchissantes sur les poignées
- bandoulière détachable



16



front

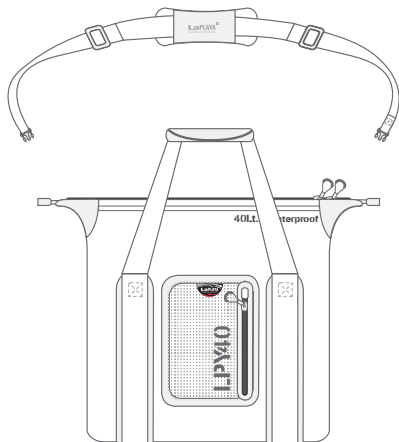

left side

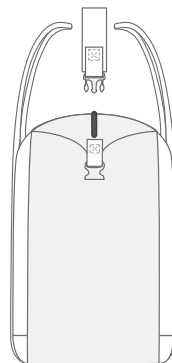

rear

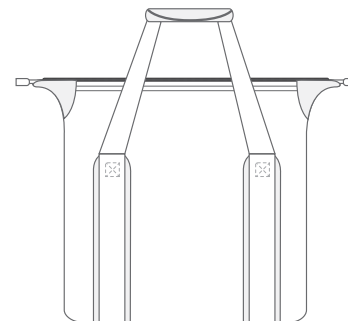

## FEATURES

Volume: 40 Lt

Size: 40 x 46 x 21 cm (W x H x D)

Material: PVC 500D Tarpaulin  
PVC mesh transparent

Colors:

- black/silver    Art. 800200
- black/black    Art. 800201
- black/white    Art. 800202

## MERKMALE

Volumen: 40 Liter

Abmessungen: 40 x 46 x 21 cm (B x H x T)

Material: PVC 500D Tarpaulin  
PVC Netz transparent

Farben:

- schwarz/silber    Art. 800200
- schwarz/schwarz    Art. 800201
- schwarz/weiß    Art. 800202

## CARACTÉRISTIQUES

Volume: 40 L

Dimensions: 40 x 21 x 46 cm (L x l x h)

Matériau: PVC 500D Tarpaulin  
PVC mesh transparent

Couleur:

- noir/argent    Art. 800200
- noir/noir    Art. 800201
- noir/blanc    Art. 800202

## Back Pack 20

- thermowelded backpack
- water resistant zippers
- inner laptop compartment
- compact shape
- comfort padded back panel and shoulder straps

- thermogeschweißter Rucksack
- wasserabweisende Reißverschlüsse
- Laptopfach
- kompakte Form
- komfortabel gepolstertes Rückteil und gepolsterte Schultergurte

- sac à dos imperméable soudé
- fermetures éclair résistantes à l'eau
- pochette intérieur pour un ordinateur portable
- compact
- avec dos et bretelles rembourrés pour plus de confort



front

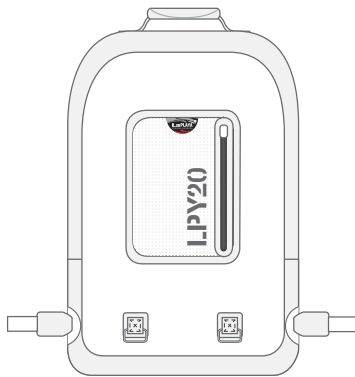

left side

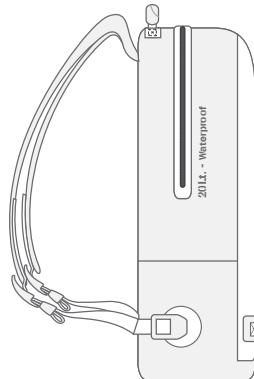

rear

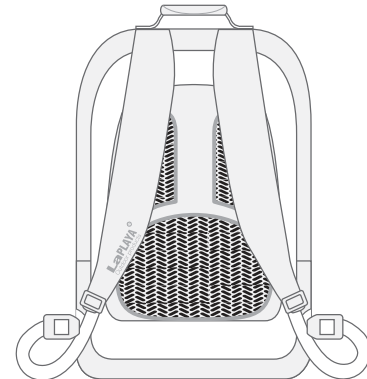

## FEATURES

Volume: 20 Lt

Size: 32 x 52 x 12 cm (W x H x D)

Material: PVC 500D Tarpaulin  
PVC mesh transparent

Colors:

- black/silver Art. 800800
- black/black Art. 800801
- black/white Art. 800802

## MERKMALE

Volumen: 20 Liter

Abmessungen: 32 x 52 x 12 cm (B x H x T)

Material: PVC 500D Tarpaulin  
PVC Netz transparent

Farben:

- schwarz/silber Art. 800800
- schwarz/schwarz Art. 800801
- schwarz/weiß Art. 800802

## CARACTÉRISTIQUES

Volume: 20 L

Dimensions: 32 x 12 x 52 cm (L x l x h)

Matériau: PVC 500D Tarpaulin  
PVC mesh transparent

Couleur:

- noir/argent Art. 800800
- noir/noir Art. 800801
- noir/blanc Art. 800802

## Messenger Bag 10

- convenient thermowelded messenger bag
- water resistant zippers
- outer pocket
- inner laptop compartment
- top flap with velcro closer system
- comfort padded back panel

- thermogeschweißte Messenger Bag
- wasserabweisende Reißverschlüsse
- Außentasche
- Laptopfach
- Taschenklappe mit Klettverschluss
- komfortabel gepolstertes Rückteil

- sac de coursier imperméable soudé
- fermetures éclair résistantes à l'eau
- pochette extérieures
- pochette intérieur pour un ordinateur portable
- compact
- avec système de fermeture velcro
- avec dos rembourré pour plus de confort



20



front open

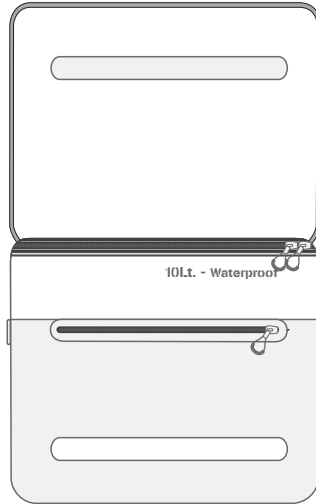

front

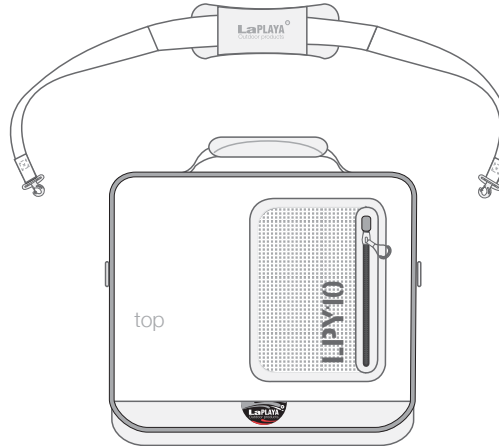

right side



## FEATURES

Volume: 10 Lt

Size: 34 x 30 x 11 cm (W x H x D)

Material: PVC 500D Tarpaulin  
PVC mesh transparent

Colors:

- black/silver    Art. 800100
- black/black    Art. 800101
- black/white    Art. 800102

## MERKMALE

Volumen: 10 Liter

Abmessungen: 34 x 30 x 11 cm (B x H x T)

Material: PVC 500D Tarpaulin  
PVC Netz transparent

Farben:

- schwarz/silber    Art. 800100
- schwarz/schwarz    Art. 800101
- schwarz/weiß    Art. 800102

## CARACTÉRISTIQUES

Volume: 10 L

Dimensions: 34 x 11 x 30 cm (L x l x h)

Matériau: PVC 500D Tarpaulin  
PVC mesh transparent

Couleur:

- noir/argent    Art. 800100
- noir/noir    Art. 800101
- noir/blanc    Art. 800102

## Bags built for outdoor lovers

*"In all things of nature there is  
something of the marvelous."*

**Aristotle**





Copyright © 2012  
LaPLAYA® Outdoor Products - IPV GmbH  
Design: [harbourseven.com](http://harbourseven.com)  
Printed in Germany

---

**LaPLAYA**®  
Outdoor products

IPV - Inheidener Produktions - u. Vertriebsgesellschaft mbH  
• EZetilstraße 1 • D-35410 Hungen-Inheiden,  
Germany

[www.laplaya.ch](http://www.laplaya.ch)

---